



Australian Institute of Sport



1997 Manual of Motor Sport

with 1997 National Competition Rules

Internet address: <http://www.cams.com.au>

CAMS



Section 6

GENERAL REQUIREMENTS FOR CARS AND DRIVERS

(Formerly Appendix C to the National Competition Rules)

Table of Contents

| | | |
|-------------------------------------|--------------|--------|
| Definitions | | 6 - 2 |
| Classification of Cars | | 6 - 4 |
| General Requirements of Automobiles | (Schedule A) | 6 - 5 |
| | (Schedule B) | 6 - 5 |
| | (Schedule C) | 6 - 7 |
| | (Schedule D) | 6 - 8 |
| Apparel | (Schedule E) | 6 - 12 |
| Wheels and Tyres | (Schedule F) | 6 - 14 |
| Aerofoils and Coachwork | (Schedule G) | 6 - 15 |
| Commercial Fuel | (Schedule H) | 6 - 16 |
| Fire Extinguishers | (Schedule I) | 6 - 17 |
| Safety Harnesses | (Schedule J) | 6 - 18 |
| Rollover Protection | (Schedule K) | 6 - 25 |
| Markings on Automobiles | (Schedule L) | 6 - 27 |
| Vehicle Log Book | (Schedule M) | 6 - 28 |
| Scatter Shields | (Schedule N) | |
| Fuel Tanks & Refuelling | | 6 - 29 |
| - Part 1: Fuel Tanks | | 6 - 31 |
| - Part 2: Refuelling in Pit Lane | | |

Definitions – General

See also "Definitions – General", Section 4, Part II

BALLAST

It is permitted to complete the weight of the car by one or several ballasts on condition that they are strong and unitary blocks, fixed by means of tools with the possibility to fix seals, placed on the floor of the cockpit, visible and sealed by the scrutineers.

BODY SHELL

The main coachwork structure of an automobile which, in the case of an automobile not having a separate chassis, constitutes the fundamental structure of the automobile. Components such as doors, bonnet, bootlid and mudguards which are readily demountable are not deemed to be part of the body shell.

BODYWORK/COACHWORK

- externally: all the entirely suspended part of the car licked by the airstream;
- internally: cockpit and boot.

WHEEL ANGLES - LIVE REAR AXLES

Unless proved otherwise (by specific reference from the manufacturer concerned or within the relevant category regulations) all production-based vehicles utilising a live rear axle are considered to be configured with parallel wheel planes.

CHASSIS

The structure of any automobile so constructed that the coachwork is a separate entity and not a primary load carrying element of the automobile. It foresees that the coachwork may contribute to the overall strength of the automobile, but the word "chassis" is applicable only to those automobiles in which removal of the coachwork does not affect the entity of the mechanical components of engine, transmission, suspension and unsprung part as an assembly.

CYLINDER BLOCK

The crankcase and the cylinders.

EVENT

An event shall include official practice, qualifying, warm-ups, the race or races, and all associated functions such as technical inspection and registration.

EXHAUST MANIFOLD

Part collecting together the gases from the cylinder head and extending to the first gasket separating it from the rest of the exhaust system.

FAMILY OF A VEHICLE

Different series models belonging to one and the same production series of the same manufacturer. At least the number of vehicles specified in the relevant Technical Regulations for the category of car with identical external general lines of the bodywork must have been produced in 12 consecutive months. The material of the bodywork and the wheelbase dimension must be identical.

All models must be available through the normal commercial channels of the manufacturer.

The general external lines of the bodywork may vary in the following details:

- shape and material of front and rear bumpers
- removable aerodynamic devices (spoilers, wings, sill mouldings)
- control and comfort equipment (sun roof, auxiliary lamps, door handles, exterior mirrors, etc)

- decorative strips and mouldings
- left and right hand drive versions
- two- and four- door versions, provided that these differ only with regard to the doors, door openings and B-pillar.

FRICION SURFACE OF THE BRAKES

Surface swept by the linings on the drum, or the pads on both sides of the disc, when the wheel achieves a complete revolution.

FUEL TANK

Any container holding fuel likely to flow by any means whatsoever towards the main tank or the engine.

IDENTICAL CARS

Cars belonging to the same production series and which have the same bodywork (outside and inside), same mechanical components and same chassis (even though this chassis may be an integral part of the bodywork in case of a monocoque construction).

INTAKE MANIFOLD

- Carburettor System: part collecting the air-fuel mixture from the carburettor/s, and extending to the entrance ports of the cylinder head.
- Injection System: part collecting the air from the air intake control device and extending to the ports of the cylinder head.
- Diesel Engine: part collecting the air at the air filter and extending to entrance ports of the cylinder head.

MAIN STRUCTURE

The fully sprung structure of the vehicle to which the suspension and/or spring loads are transmitted, extending longitudinally from the foremost front suspension on the chassis to the rearmost one at the rear and within the lateral protection structures.

MANUFACTURING STANDARDS

It is not permitted to modify components, even though the end result may fall within a permitted range, unless specifically authorised in the relevant Technical Regulations for the Group or Category.

MEASURING TOLERANCES

When measurements are taken by a scrutineer or technical commissioner, the following measuring tolerances apply:

- Bore and stroke $\pm 0.1\text{mm}$
- All machining (except bore and stroke) including fan, crankshaft bearings, connecting rod bearings, valves, exit port or carburettor, venturi, exhaust and clutch: $\pm 0.2\%$
- Distance from gudgeon pin centre line to highest point of piston crown: $\pm 0.5\%$
- Unfinished castings: $+4\% - 2\%$
- Cam lift: $+ 1\%$
- Weight of flywheel, clutch, crankshaft, connecting rods, pistons: $+7\% - 0.3\%$
- Width of car at front and rear axles: $+1\% - 0.3\%$
- Wheelbase: $\pm 1\text{mm}$
- Track: $\pm 25\text{mm}$

Definitions – General (continued)

If no tolerance is expressed in the recognition documents, the above-mentioned tolerances apply. If a tolerance or range is expressed, then these tolerances do not apply.

MECHANICAL COMPONENTS

All those components necessary for the propulsion, suspension, steering and braking as well as all accessories whether moving or not which are necessary for their normal working.

MECHANICALLY IDENTICAL

A component will be considered as being "mechanically identical" if it performs exclusively the original function/s foreseen by the manufacturer and it permits the attachment of any secondary components in the original manner and without modification of those components.

MINIMUM WEIGHT

The real minimum weight of the empty car (without persons or luggage aboard). All tanks containing liquids (lubrication, cooling, braking, and heating if necessary) must be filled to the level laid down by the manufacturer, with the exception of the windscreen washer container and that of the brake cooling system if the car is fitted with one; the exception is the fuel tank/s, which must be empty of fuel.

MONOCOQUE

A form of motor vehicle body construction in which all or most of the stresses are carried by the skin.

PARC FERME

Parc fermé is the place to which competitors are obliged to take their car as provided for in the Supplementary Regulations of the event. Inside *parc fermé*, only officials who are required to be there may enter. No operation, checking, tuning or repair is permitted unless authorised by the responsible official, and then only as provided for in the regulations for the event.

In most competitions in which scrutineering is provided for, provision for *parc fermé* is compulsory. Supplementary Regulations shall specify where the *parc fermé* will be established. It must be in close proximity to the finish line in the case of races, or the finish area in the case of rallies. The area between the finish line and the *parc fermé* shall be placed under the same regulations as for *parc fermé*.

Parc fermé shall be of adequate dimensions and well secured so as to ensure that no unauthorised persons may gain access whilst cars are in the enclosure. Surveillance should be carried out by officials appointed by the promoters. These officials are responsible for the operation of the *parc fermé* and only they are authorised to give orders to competitors.

The control areas of rallies are considered *parcs fermé*. No repairs or assistance may take place within the control areas.

PERIMETER OF THE CAR SEEN FROM ABOVE

The car as presented on the starting grid for the event in question.

PRODUCTION CARS

Cars of which the production of a certain number of identical (see definition of "identical cars") examples within a specified period of time has been verified at

the request of the manufacturer, and which are destined for normal sale to the public.

RACING WEIGHT

The weight of the car during any practice or race, including the driver wearing all normal racing apparel including helmet. No fuel may be added after the conclusion of any race or practice before the car is weighed. (See also "Ballast".)

ROCKER PANELS

The external body panel extending horizontally from front to rear mudguard panels, and from sill to the lower extremity of the coachwork, when the automobile is viewed in side elevation.

SEAT

The two surfaces making up the seat cushion and seatback or backrest.

- *Seatback and Backrest*: Surface measured upwards from the bottom of a normally seated person's spine.
- *Seat Cushion*: Surface measured from the bottom of the same person's spine towards the front.

SILLS

Those components of the body shell, generally in a horizontal plane, which constitute the lower extent of the door openings.

SPOILER

An attachment to one surface for the purpose of interrupting or "spoiling" the airflow across the surface and thus affecting the lift (or downforce) otherwise achieved.

TRACK

To determine the track of any vehicle, the following procedure is to be followed:

- the vehicle should be in "ready to race" condition, but without the driver aboard;
- determine the centre of the tread of each tyre, at the same height above the road, and mark that place with a spot of paint;
- the centre should be determined using the full width of the tyre, ie, the extremities of the bag;
- the vehicle should be rolled forward so that it leaves two marks on the road;
- measure the distance between the centres of the marks to determine the track.

WHEELS

"Wheel" means flange and rim; "complete wheel" means flange, rim and tyre. *Measuring wheel width*: the complete wheel width is to be measured with the wheel mounted on the car on the ground, the vehicle in race condition, driver aboard, at any point along the circumference of the tyre, except in the area in contact with the ground.

WING

A wing/aerofoil functions on what is termed the "velocity effect" and essentially involves airflow over both upper and lower surfaces of the section. Essentially, the function of a wing/aerofoil is to produce lift (or downforce) in the configurations used in motor sport applications).

Classification of Cars

1. RECORDS

For the purpose of attempting speed and/or endurance records, vehicles will be classified according to their calculated effective engine capacity, using the relevant factors as noted below.

Vehicles will then be placed in one of the following classes:

VEHICLES WITH POSITIVE DISPLACEMENT RECIPROCATING ENGINES

| | |
|-------------|--------------|
| Over 8000cc | FIA Class 11 |
| 5001-8000cc | FIA Class 10 |
| 3001-5000cc | FIA Class 9 |
| 2001-3000cc | FIA Class 8 |
| 1501-2000cc | FIA Class 7 |
| 1101-1500cc | FIA Class 6 |
| 751-1100cc | FIA Class 5 |
| 501-750cc | FIA Class 4 |
| 351-500cc | FIA Class 3 |
| 251-350cc | FIA Class 2 |
| Below 250cc | FIA Class 1 |

(See "Supercharging", below)

2. GENERAL (applies to all competition unless specifically noted otherwise)

2.1 VEHICLES WITH ROTARY COMBUSTION (WANKEL-TYPE) ENGINES

The engine capacity will be calculated by the following FIA formula: 1.8 times the volume determined by subtracting the minimum capacity of the working chamber/s from its/their maximum capacity gives the piston displacement equivalence (and hence the relevant class).

2.2 SUPERCHARGING

If the engine of a car includes a separate device for supercharging it, the nominal cylinder capacity will be multiplied by a factor of 1.7, and the car will be classified in all respects corresponding to the nominal volume thus obtained.

A supercharger is deemed to be:

- a device designed to produce and capable of producing positive (above atmospheric) pressure in the induction system of an engine throughout its operating range;
- any device which effects a measurable increase in the BMEP.

NOTE: a dynamic air inlet for ducting air from the atmosphere into the engine intake shall not be considered as a supercharging device.

2.3 VEHICLES WITH ELECTRONIC, TURBINE, OR STEAM ENGINES

For the purposes of record attempts, such vehicles are allotted to classes on a basis of unladen weight:

| | |
|-------------|---------|
| Up to 500kg | Class 1 |
| 501-1000kg | Class 2 |
| Over 1000kg | Class 3 |

Specific determination insofar as class allocation for racing purposes is concerned will be made on application to CAMS.

- In competitions other than attempts on records, automobiles shall be classified as follows:

3.1 1st Category: Racing Cars

Australian Formula 2
Formula Holden
Formula Ford
Formula Vee
Formula Libre (in races) up to 1300, 1301-2000, 2001-3000, 3001-5000cc

(In other speed events) as for Record classes, or as for races.

3.2 2nd Category: Sports Cars (Open, Closed and Marque) in the following capacity classes:

Up to 1300cc
1301-1600cc
Clubman - up to 1300cc only.
1601-3000cc
3001-5000cc

3.3 Sports Sedans & Club Cars, in the following capacity classes:

Up to 1300cc
1301-2000cc
2001-3000cc
3001-4000cc
4001-6000cc

3.4 HQ Holdens

3310cc only

3.5 Porsche Cup Vehicles - when competing in competitions under the Australian Porsche Cup regulations, cars are classified according to their weight-to-power ratio and then compete in one of three corresponding classes.

3.6 3rd Category: Production Cars

Up to 1300cc
1301-1600cc
1601-2000cc
2001-3000cc
3001-6000cc

3.7 4th Category (Other Automobiles)

As may be specified in Regulations.

3.8 5th Category (Historic Cars)

As may be specified in Regulations.

- NOTES:** Organisers are permitted to amalgamate any adjoining classes, but not to use any other class limits than those stated for the relevant category or group.

In all International and National Competitions events shall be conducted only in accordance with the above categories, unless specific written authority is granted by CAMS to classify otherwise.

General Requirements of Automobiles (Schedules A, B and C)

Schedule A

ALL AUTOMOBILES SHALL, OF NECESSITY, IN ALL COMPETITIONS:

- comply with the definition of an automobile; and
- be fitted with some form of protection between engine and driver's compartment suitable and sufficient for preventing the passage of flame; and
- be so constructed that the driver is protected from the entry of foreign matter into the driving compartment from the road or road wheels; and
- be equipped with a transmission system so arranged that:
the propeller shaft and universal or Cardan joints, if passing through or beneath the passenger compartment, shall be under the floor boards, or fitted in tubes or casings. Such floorboards, tubes or casings shall not be of a temporary nature, but shall be joined together and firmly fixed to the coachwork or chassis. Any chains used in the transmission of power or driving any auxiliary component shall be effectively guarded; and
- be arranged so that all fuel tanks are vented externally to the bodywork; and
- if not registered for use on public roads, have any steering column locking device removed; and
- if required to be fitted with roll-over protection, be equipped with such protection only in accordance with the provisions of Schedule J; and
- unless specifically otherwise approved, use only commercial fuel, as defined (Schedule G); and
- be fitted with windows (including wind-screens) which if of other than glass, are clear, transparent and free of colouring; glass windows must not be coloured or tinted after production; and
- have displayed on the dashboard a valid CAMS registration label for the relevant competition as determined by CAMS from time to time, save for Off Road events, Kart races, Motorkhanas, Speed Events and Historic Category 5 vehicles; and
- be fitted with safety harness or seat belts as prescribed in Schedule I; and

Schedule B

ALL AUTOMOBILES SHALL, OF NECESSITY, IN ALL SPEED EVENTS:

- be fitted with at least two independent fastening systems, of adequate strength and limited extensibility, which simultaneously hold the bonnets or panels closed; and
- (if fitted with crankcase breather/s discharging to atmosphere) have fitted to such breather/s an oil-trap container (which must be empty at the start of the competition) of at least two litres (for cars of under 2000cc) or three litres (for cars of over 2000cc) except in Autocross, Rallycross and other events on unsealed surfaces, save however, that Supplementary Regulations may require fitment for any particular event; and
- (other than Single- and Multi-car Speed Events) be fitted with a roll bar or roll cage and safety harness complying with such specifications as are determined by CAMS from time to time (see Schedules J and D).
(NOTE: structurally unmodified fixed roof closed cars may compete in events other than National Race Meetings without roll-over protection) and
- be fitted with a fire extinguisher or fire extinguishing system in working order and of a type and capacity as specified in Schedule H as is appropriate; and
- be so constructed that, in the event of any breakage, the tailshaft, its components or mountings shall be effectively prevented from striking the ground; and
- be fitted with wheels which meet the specifications determined by CAMS from time to time (see Schedule E); and
- be so constructed that any aerodynamic device fitted is in accordance with specifications determined by CAMS from time to time (see Schedule F); and
- comply with any Supplementary Regulations for a specific event which requires the fitment of locking or wiring devices adequate for the prevention of any loosening of any oil drain plug; and
- be fitted with a scatter shield if required under the provisions of Schedule M; and
- on each throttle, whether butterfly, slide or other type, be fitted with a return spring which in the event of the throttle linkage becoming detached will in all cases return each throttle to the closed position; and
- be fitted with a double circuit braking system so arranged that the pedal normally operates on the four road wheels and, in the event of leakage at any point in the braking system, the pedal shall still control two wheels on the same axle. Provided that in "straight-line" Sprint Events, and in events exclusively for historic or vintage cars, braking systems

Schedule B (continued)

- operating on two wheels of the same axle shall be acceptable; and
12. be fitted with an operable reverse gear; and
 13. be fitted with an exhaust system the outlet pipe/s of which shall be directed either rearwards or sideways. If rearwards, their orifices shall be between 100mm and 450mm above the ground and they shall not protrude by more than 150mm beyond the rearmost portion of the car. If they are directed sideways, their orifices must be located aft of a vertical plane passing through the midpoint of the wheelbase. They may neither project in any way beyond the maximum width of coachwork nor terminate at a point more than 50mm within the projected plan of the coachwork. Adequate protection shall be provided to prevent heated exhaust pipes from causing burns (not 1st Category cars).
 14. have, on the external coachwork, a blue triangle of sides 150mm, which indicates the position of the battery or the isolation switch; and
 15. be fitted with a flame- or liquid-proof bulkhead, which may be of transparent material, which effectively separates the compartment occupied by the crew from any component of the fuel tank or fuelling system.

Notwithstanding the above requirements cars registered for road use shall not, when competing in one-car-at-a-time speed events, be required to comply with the provisions of sub-sections 2, 3, 5, 8 and 9 of this Schedule.

Schedule C

ALL AUTOMOBILES IN CIRCUIT RACES SHALL, OF NECESSITY, IN ADDITION TO THE PROVISIONS OF PRECEDING SCHEDULES A & B:

1. Be fitted only with laminated glass in any glass windscreen.
2. Be fitted with tyres which have not been re-treaded, recapped, repaired or in any way are re-conditioned; if tubeless racing tyres, shall have been fitted only to suitable rims; if tubeless touring tyres, may be fitted only to rims classified as optimum sizes for the covers concerned (fitting of such tyres to so-called "permissible" or oversize rims is specifically prohibited); in all cases, shall be required to carry a manufacturer's speed rating appropriate to the type of automobile and competition concerned (see Schedule E).
3. Be fitted with bodywork which generally encloses (when viewed from above and each side) the chassis frame and basic mechanical elements, from the front of the automobile rearwards to the vertical plane immediately to the rear of the driver's seat. Provided that, in the case of a vehicle driven by a provisional licence holder, such further panel/s must be fitted as may be necessary to comply with the requirements of Schedule K, Article 2.
4. Be fitted with at least two rear vision mirrors of which each must have a reflecting surface of at least 50cm², and provide an unobstructed view to the rear of the car, save that, in automobiles with closed body-work (whether of sports or touring types), one such mirror shall be fitted internally and one externally.
5. Be fitted with a fuel tank as specified in Schedule N as is appropriate.
6. Be fitted with towing points complying with the following:
 - have an internal diameter of at least 40mm;
 - are fitted forward of the front axle and rearwards of the rear axle;
 - are clearly visible and painted in yellow, orange or red, the chosen colour being in contrast to the colour of the body work immediately adjacent the towing point;
 - are constructed and fitted in such a way that when a load is applied to the towing point, parallel to the ground and in a direction facing away from the vehicle, parallel to the longitudinal centre line of the vehicle, the vehicle shall be capable of drawing the car over two blocks of 100mm height. These blocks shall be of a section 100mm x 200mm, not less than the width of the tyre and shall be placed immediately "in front" of the tyres closest to the towing point being subject to the applied load.

In order to test the strength of the towing point, any non-structural body work which interferes with the test may be removed.
7. Be fitted with fuel lines only of metal, braided

Schedule C (continued)

8. Neoprene, or other CAMS approved material. In closed cars first registered with CAMS after 1 January, 1980, and in which the relevant regulations permit the replacement of the driver's seat, be fitted only with such replacement seat which:
 - incorporates a head restraint;
 - has no provision for mechanical adjustment of the rake of the squab.
9. Where a seat is a separate entity to the structure of a vehicle and it is not supported by the structure, and where the standard seat mountings are not retained or the vehicle does not comply with the Australian Design Rules for seat mountings, the seat shall be mounted by not less than four 8mm (5/16") bolts. Where they are affixed to the unreinforced section of the floor pan, these attachment points shall be reinforced by the use of plates of not less than 75mm x 50mm x 3mm (1/8" thick).
10. Be configured so that, when measured in competition conditions at 30m from the track edge, the sound emission from the vehicle does not exceed 95dB(A).
11. Be fitted with an effective and efficient muffler, which diminishes the sound of the engine's exhaust.
12. On vehicles with fuel injection systems, the power supply to all fuel pumps must be cut off after a maximum of six seconds absence of crankshaft revolution.

VELO

SEATS





RALLY
RACE
ROAD
DRAG
HISTORIC
OFF ROAD

Australian Made

F.I.A. 8855 - 1992
VELO
 GP-90 1996
 CS.674.95
MADE IN ADELAIDE, AUSTRALIA



Pictured is the Podium FIA seat with lateral head restraint

- Construction in G.R.P. Glassfibre, Kevlar Composite, Carbonfibre Kevlar mix.
- **VELO seats are manufactured to exceed Australian Design Rules, A.D.R. and F.I.S.A. (FIA).**
- All seats are available in a wide range of sizes or made to order.
- Personal embroidery available, e.g. name, team, sponsor, etc.

For your nearest supplier
telephone: (08) 8369 0488
facsimile: (08) 8369 1448
9/26 Jacobsen Crescent, Holden Hill
Adelaide, South Australia. 5088



as chosen by Glenn Seton Racing











REVOLUTION RACEGEAR  

Phone Orders: **1800 804 778**
To reach your nearest REVOLUTION STORE



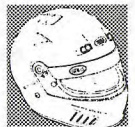

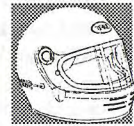

FREE CALL

Worn By The Best

BELL HELMETS

| | | |
|--|--|--|
|  RS 4 • 449 |  RS 3 • 399 |  SPORT 2 • 499 |
|  M3 • 895 |  MAG 4 • 395 |  AFX 1 • 789 |
|  SPORT 2 • 649 |  VORTEX • 1375 |  SR PRO • 549 |
|  XFM 1 • 695 |  MAG 5 • 549 |  M 2 • 549 |

Arai HELMET

| | | |
|--|---|--|
|  GP 3 • 1499 |  GPK • 649 |  T-790 • 125 |
|  GP-C • 849 |  GP Jet • 499 |  T-380 • 69 |

RPM HELMETS

Schedule D – Apparel

Races, Speed Events & Off Road Events

1. HEADGEAR

NOTE: Events which are entered on the FIA International Sporting Calendar have restricted standards for allowable helmets. Standards approved by the FIA for international competition are accepted by CAMS for domestic competition.

It is compulsory, in all races and other speed events and in other events where helmets are required, that drivers wear helmets of a standard design, construction and fitting approved by CAMS.

Helmets not marked as complying with the approved standard may be approved by CAMS under certain conditions.

All helmets must bear a CAMS-approved label affixed by an authorised official.

It is advised that painting or use of solvents on helmets could be hazardous.

Balaclavas are mandatory for international races and are recommended in all competitions, especially for drivers with long hair and/or beards.

In kart races, it is compulsory for drivers to wear a full face helmet.

Helmets bearing any of the following marks are approved for use in racing, speed events, special stage rallies and other events where helmets are required and the event is not entered on the FIA International Sporting Calendar:

| | |
|--|---------------------|
| AS1698 | Australian Standard |
| Snell SA80, M80, SA85, M85, SA90, M90, SA95 | USA Standard |
| SFI Spec 31.1 | Australian Standard |
| SFI Spec. 31.2 | USA Standard |
| SIS 88.24.11 (2) | Swedish Standard |
| DS 2124.1 | Danish Standard |
| SFS 3653 | Finnish Standard |
| ONS/OMK | Germany Standard |
| NF S 72 305 | French Standard |
| E22 with (02, 03 or 04 amendments) | European Standard |
| BS 6658-85 Type A (incl. amendments) | British Standard |
| BS 2495-1977 | British Standard |

NOTES:

1.1 Helmets permitted for events entered on the FIA international sporting calendar, or events organised under the authority of an ASN other than CAMS, will be restricted to those bearing one of the following approvals:

- Snell Foundation SA 90, SA 95 (USA)
- SFI Foundation Inc, SFI Spec 31.1 or 31.2 (USA)
- British Standards Institution BS 6658-85 type A including all amendments (Great Britain)

1.2 No helmet may be modified from its specification as manufactured except

Schedule D – Apparel (continued)

in compliance with instructions approved by the manufacturer and one of the standards organisations listed above, which certified the model concerned. Any other modification will render the helmet unacceptable for the requirements of this regulation.

- The FIA has advised that communication systems in helmets must have been tested with that model of helmet for standard assessment. Any subsequent additions or modifications to facilitate communication or breathing devices may invalidate helmet certification.
- Decoration of helmets is potentially dangerous, and members are warned of the hazard of using paint on approved helmets.
- Drivers are cautioned against using helmets which have been damaged or involved in accidents.

2. GOGGLES

Goggles or visors must be worn by drivers of open cars. Those with glass lenses of any kind are not acceptable. Lenses shall be of a plastic material, with high-impact resistance, satisfactory optical qualities and complying with Australian Standard Specification AS 1609-1981.

Races

3. CLOTHING

In all circuit races and practice therefor, all drivers shall be required to wear approved clothing as follows:

- one-piece overalls of an approved flame resistant material, extending from wrists to neck to ankles, together with
- heat-resistant underwear, extending from wrists to neck to ankles, and of a woollen or such other material as may be specifically approved by CAMS, and
- socks of undyed wool or other flame retardant material, worn under flame resistant boots or shoes which completely enclose the feet (driving without such footwear is forbidden).
- gloves of recognised flame retardant material. No apparel of flammable material (eg, nylon or similar synthetics) may be worn in any race. Neither two-piece overalls nor Proban-treated material is approved.

NOTE: For races entered in the FIA International Sporting Calendar, overalls must comply with FIA regulations (1986 Standard) and other apparel items must have satisfied ISO6940 standard using exposure times of five and 15 seconds and that after flaming times do not exceed five seconds.

Superkart Races and Practice

In all Superkart races and practice, drivers must wear a one-piece abrasive resistant race suit (or two-piece suit securely fastened at the waist), which is securely fastened at the wrists

sparco

The winning EDGE 



Sparco racewear, safety equipment and seats have dominated worldwide motorsports by offering safety, quality, comfort, and style that has been developed in conjunction with leading teams and drivers and tested in the most extreme conditions before they are entered into standard production.

So if you're committed to using the highest quality and latest technology, put your safety in Sparco's hands just like leading teams do, such as Newman Haas, Benetton Formula, Williams, Jordan, Team Rahal and many more.

Australian motorsport needs equal safety consideration - so specify Sparco for your motorsport needs - Helmets, Racesuits, Safetywear, Gloves, Boots, Seats, Extinguishers, Steering and Road Wheels, Competition Equipment.





sparco Available throughout Australia ..enquiries R&R SPEEDSPORTS Pty.Ltd. - Sydney Phone: 02-9709 4655

Schedule D – Apparel (continued)

and ankles. In the 250cc classes, the suit must be of leather. For all other classes, the material may be leather, cordura, or cordulon.

In all Superkart races and practice therefor, drivers must wear:

- footwear, securely fastened which covers and protects the ankles;
- abrasive resistant gloves that cover and protect the hands and wrists (including the fingers).

Superkart drivers may wear appropriate wet weather clothing in addition to that specified.

It is recommended that acoustic ear plugs be worn.

4. PIT CREW

All persons working on cars must wear shoes and socks, neck to ankle covering, and at least a short sleeved shirt. On race day, pit crew must be neatly attired. Promoters are authorised to refuse entry to the pit area of people unsuitably dressed.

In races where refuelling operations are permitted, any persons involved in such operations must be attired to the same minimum standards as that appropriate for drivers in races (see 3 (i), (ii), (iii) and (iv) above). In

addition, balaclavas must be worn and any resultant exposed areas (eg, eyes) must be covered and enclosed by flame-resistant material. The wearing of full-face helmets is recommended in addition to the above.

5. SPEED EVENTS

In speed events, clothing for drivers and crew members must be from ankles to neck to wrists. Clothing and footwear of flammable synthetic material, such as nylon, is not acceptable.

Rallies

6. No person may compete in any rally of Australian Championship, International or Special Stage status unless wearing, in other than "transport" stages, a properly fastened helmet of a model listed above.
7. No person may compete in any open rally or any rally timed to intervals of less than one minute unless wearing shoes and socks, a shirt with at least short sleeves, and clothing from neck to ankle.
8. It is strongly recommended that no apparel of flammable material (eg, nylon or similar synthetics) be worn.

Schedule D – Apparel (continued)

All Events

9. No driver shall participate in any competition unless wearing suitable and appropriate footwear. Prohibited are, for example, thongs, Roman sandals and high-heeled shoes.

Drivers shall continue to comply with the requirement of Rule 141 until such time as they leave their automobiles.





Phone Orders: **1800 804 778**
To reach your nearest
REVOLUTION STORE



THE CHOICE OF CHAMPIONS

Complete Package Deals Available



Prostyle
From \$549



National
From \$298



Corsa
From \$699



Drag suits
From \$325



Bathurst
\$125



Club
\$75



Group A
\$99



Clubsport
From \$198



Balaclavas
From \$45



Pro
\$125



Sprint
FIA Spec
\$169



LeMans
FIA Spec
\$189



Indy
CIK Spec
\$125

KEEP YOUR COOL.

Now, **Flamecrusher driving suits** are available in the new PROTEK fabric... an innovative development representing the latest advancement in flame retardant fabrics.

Not only safer but more comfortable... because it's made from natural fibre, PROTEK fabric breathes, allowing body heat to be transferred away from the wearer in hot conditions, yet the same fabric offers warmth in cooler conditions.

Designed for your Safety and Comfort:

- Multi or Single Layer Lightweight Construction
- Standard and Tailored Sizes
- Custom Design available
- Five Standard Design Styles
- Wide Range of Colours
- FIA Approved

FLAMECRUSHER RACEWEAR

Contact: Ken Price Tel: 03 9722 9000 Fax: 03 9723 1999
114-118 Taylor Road, Mooroolbark, Victoria 3138

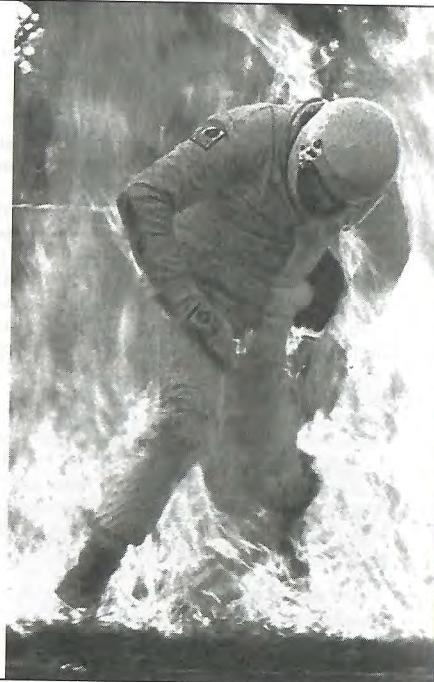

Think Motorsport Gear ? ..think RACE & RALLY !



RACE & RALLY was established in 1962 to supply motorsport equipment to Australian competitors from one central location and alleviate the need for endless searching and despair. This philosophy continues today and RACE & RALLY continue to bring you the best equipment the world has to offer at the most competitive prices, fast delivery and after sales service.

Our stock range caters for all forms of motorsport from karting to Formula Australia and everything in between. Product homologations include FIA, CIK, CAMS, ASCF, AKA, SFI, ANDRA ... we care!

LOOK FOR THIS LOGO IN THE GOODS & SERVICES DIRECTORY OF THIS CAMS MANUAL ...ITS YOUR GUARANTEE OF SATISFACTION!

RACE & RALLY Motorsport

TEAM MANAGERS! Do you want your team to be seen?

EMERSON Racewear and Teamwear is a division of RACE & RALLY and specialise in small run production of quality Team Apparel. Collared Shirts, Jackets, Overalls, T-Shirts, Sweats, Pants, Shorts, Aprons and Caps.



NO ORDER IS TOO LARGE OR TOO SMALL .. YOU CAN CONTACT US WITH DETAILS/SKETCHES on FREE FAX

1800 683 131



"Best Presented Team"
NATIONS CUP
1994 & 1995

Your Enquiry Welcome

SPEEDGRAFIX
COMPUTER GENERATED SIGNAGE FOR RACE CARS

RACE & RALLY Pty.Ltd.
35 ROSEDALE AVE, GREENACRE, NSW 2190, AUSTRALIA
Tel: 02-9709 4655 OR FACSIMILE ON 02-9709 4665

Schedule E – Wheel and Tyres

The following requirements and parameters apply to all competitions.

1. **RIM WIDTH**
1st Category: Racing Cars
2nd Category: Sports Cars and cars complying with Clubman Sports 1300 Formula.
 Where a steel centre is employed, the width of any rim attached thereto shall not exceed the following:
 - cars up to 2000cc capacity and Clubman: 8.5"
 - cars over 2000cc capacity: 10"
 - if a steel centre is not utilised, the width is unrestricted.**2nd Category: Other Cars**
3rd Category: Touring Cars
 - (i) where a steel wheel centre supplied by a vehicle manufacturer as original vehicle equipment is employed, any rim attached to such centre shall not be more than 2" wider than the rim originally fitted to such centre.
 - (ii) wheels and steel centres other than those supplied by a vehicle manufacturer as original vehicle equipment may not be widened.
2. **TYRES**
 - 2.1 Tyres fitted to all rims shall be in accordance with the Tyre and Rim Association recommendations.
 - 2.2 Tyres not listed in the Tyre and Rim Association Manual are to be subject to certification by the manufacturer as being suitable for the rim width concerned.
 - 2.3 The tread wear indicators as provided by the relevant tyre manufacturer will be the definitive method of determining minimum tread depth. At no time prior to any official practice or racing may the tread wear indicators be exposed or, in those cases where the tread wear indicator is a dimple in the tyre, worn below such indicator. This does not apply to the shoulder of the tyre where excessive wear may occur due to steering and cornering.
 Tyres may be checked by an official in the marshalling area prior to the start of any practice session or race. Any vehicles found not to comply with these regulations may not be permitted on to the circuit.
3. **WET WEATHER TYRES**
 - 3.1 Clerks of Course may, after consultation with the stewards and at an appropriate time announce that "untreaded tyres are not to be used until further notice".
 - 3.2 As most untreaded racing tyres are not suited for other than dry tracks, scrutineers must ensure that (for circuit races and tarmac rally stages):
 - (i) on wet days only suitable tyres are used; this will exclude specialised dry tyres, unless they have been suitably modified.
 - (ii) tyres used are suitable for the weather and track conditions relative to the car's potential.
 - (iii) that all tyres used or likely to be used are scrutinised (competitors, too, must ensure that this is done).

General Requirements of Automobiles (continued)

Schedule E – Wheel and Tyres (continued)

- (iv) by checking, in the marshalling area, that late changes have not been made which render the cars unsuitable for use.
- 3.3 Championship and long distance races will be subject to special decisions. If a specific order is to be made, it will be that the race will commence on treaded tyres.
 Competitors would thereafter be free to change. This order will be made in respect of those races if:
 - (i) it is raining at the start, and the track is wet, or
 - (ii) it is not raining at the start but the track is "running" with water over the greater part of its length.
- 3.4 In Formulae where a specific dry weather tyre and/or wet weather tyre are specified, the wet weather tyre may be used only under conditions (i) and (ii) in paragraph 3.3 above.
4. **CONTROL TYRES**
 Where specific tyres, otherwise known as control tyres, form part of a formula, those tyres are as much a part of the formula as is everything else which describes the car.
 Specified control tyres may not be

modified, other than by reduction of tread depth. In all competitions in which the car is entered under a specific formula, those control tyres must be used.

If the car is not competing in a particular formula, but only as a "racing car", then the competition must be assumed to be for cars of Formula Libre, and control tyres are then not required.

The provisions of this Article, whilst specifically referring to control tyres, which are traditionally one make/model of tyre used in a given application for a number of cars in a single class, also extend to those classes and categories where a limitation is placed on the types or make/models of tyres which are permitted to be used. Examples given are: Group 3E Production Cars, Historic Group N cars.

It is reiterated that in these classes, the permitted range of tyres to be used by a competitor form as much a part of the Technical Regulations as do the actual regulations themselves and any restrictions to modifications of tyres stated or implied in Article 4 of Schedule E also apply to those classes.

Maximum Permissible Rim Widths

| Category | Vehicle | Maximum Widening Permitted | | Max. Rim Width for Steel Wheels | Maximum Rim Width other than Steel Wheels |
|----------|------------------------------|----------------------------|-----------------------|--------------------------------------|---|
| | | Prod. Steel Wheels | Non-Prod Steel Wheels | | |
| 1 | Racing F/Holden F/Ford F/Vee | Unrestricted | None | 8.5" up to 2000; 10" over 2000 | Unrestricted |
| | | None | None | 5.5" | 5.5" |
| | | None | N/A | 5.5" | N/A |
| 2 | Sports Cars | Unrestricted | None | " | " |
| Clubman | - | Unrestricted | None | 8.5" | Unrestricted |
| 2 | Other cars | 50mm (2") | None | 8.5" up to 2000; 10" over 2000 | As determined by vehicle regulations |
| 3 | | 50mm (2") | None | As determined by vehicle regulations | As determined by vehicle regulations |



Australian Distributors for

MANSONS Racing Tyres
Tyres designed for Champions

For more information see our listing under Tyre Buffing, Tyres & Wheels in the Goods & Services Directory

VIC 546 Mountain Highway, Bayswater (03) 9720 8444
NSW 20 Pilcher Street, Strathfield South (02) 9642 1077

Schedule F – Aerofoils and Coachwork

The following are the CAMS (and FIA) parameters regarding the fitting of aerofoils and other aerodynamic devices to cars.

- For all vehicles (1st, 2nd, 3rd, 4th and 5th Categories) coachwork shall be deemed to include all external parts of the car which extend above the highest point of either the front or rear complete wheels (with tyres) with the exception of units definitely associated with the functioning of the engine or transmission and the roll bar.

Any specific part of the car which has an aerodynamic influence on the stability of the vehicle must be mounted on the entirely sprung part of the car and shall be firmly fixed whilst the car is in motion.

Neither the roll bar nor any of the units associated with the functioning of the engine or transmission shall have an aerodynamic effect by creating vertical thrust.

All external projections swinging in a horizontal plane shall have a minimum radius of 15mm. The leading edge of any aerofoil fixed to the front of the car shall not be sharp.

Switches for battery isolation and fire fighting equipment may project beyond the coachwork without infringing regulations.

- 2nd Category** vehicles shall comply with the following requirements (except for cars which comply with Sports Sedan Regulation 3.5 (iv)): the highest point of any forward facing gap in the coachwork shall not be situated above a horizontal plane 800mm above the lowest point of the entirely sprung structure of the car. The

maximum width of coachwork shall not exceed by more than 200mm the maximum width between the two vertical planes tangent to the outer faces of the front/rear wheels.

- 1st Category** vehicles shall comply with the following requirements:
 - No element of coachwork may exceed in height a horizontal plane situated at 900mm above the ground. Neither the roll bar nor any of the units associated with the functioning of the engine shall be included. Measurements are to be taken with the driver on board.
 - Cars of a type registered at 1 January, 1975, but constructed after 1 July, 1975; and cars of a type not registered at 1 January, 1975, but constructed after 1 January, 1976; and cars registered at 1 January, 1975, but which have subsequently been substantially varied; must all comply with the following requirements:
 - Wheels shall be external to the coachwork.
 - The coachwork opening giving access to the cockpit must be at least 600mm long; and 450mm wide, maintained over 300mm from the rearward point of the seat backrest towards the front. It must be able to be entered or left without it being necessary to open a door or remove a panel. Sitting at his steering wheel the driver must be facing forwards. Moreover, the cockpit must be so conceived that the maximum time necessary for the driver to get out does not exceed five seconds.

| | F/Holden | F2 | FF |
|---|------------|--------------|---------|
| • Maximum width ahead of front wheels | 1,500mm | 1,500mm | 950mm |
| • Maximum width ahead of front wheels, above height of wheel rims | 1,100mm | 1,100mm | 950mm |
| • Maximum width between front and rear wheels + deformable | 1,300mm | 1,100mm | 1,300mm |
| • Maximum width behind rear wheels | 1,100mm | 1,100mm | 1,100mm |
| • Front overhang | | max. 1,000mm | |
| • Rear overhang (from centre of wheel/axle) | max. 800mm | 1,000mm | |

Schedule G – Fuel

“Commercial fuel” is defined by CAMS in Articles 1, 2 and 3 below, and unless specifically permitted otherwise in the specific regulations for a vehicle, or specifically approved by CAMS, is the only fuel to be used in competition.

1. For All Spark-ignition Engines (Reciprocating and Rotary)

A “motor” fuel produced by an oil company and currently distributed at roadside refuelling stations throughout the territory of CAMS. This shall include the normal “unleaded”, “premium unleaded and “leaded” motor fuels. Additionally, a gasoline complying with the recognised specifications for 100/130 AVGAS, produced by an oil company and currently distributed for commercial aviation use throughout the territory of CAMS.

- In all events in which the use of commercial fuel is mandatory, such fuel must contain a maximum of two percent oxygen and one percent nitrogen by weight; the remainder of the fuel consisting exclusively of hydrocarbons and not containing any alcohols, nitro compounds or other power-boosting additives. Only air may be mixed with the fuel as an oxidant.
- Suppliers of fuel to entrants in any competition shall be required to send to CAMS samples of such fuel at such times and in such quantities as CAMS may decide, together with a declaration that such fuel complies with these Rules.
- Nothing in the foregoing shall be deemed to prohibit the addition of water or a lubricant which does not increase the octane rating or specific heat content of the fuel.
- Liquefied petroleum gas (LPG) is acceptable as a commercial fuel. Where a vehicle utilises liquid petroleum gas a sign, on a red reflective background of size 150mm x 150mm, must be placed immediately to the left and centralised vertically to all competition numbers. The sign must have white lettering with the words “LP Gas” in letters at least 40mm in height, as shown below.



NOTE: Any other gasoline or petrol (eg, AVGAS 115/145) of higher rating than that specified is NOT permitted when “commercial fuel” is specified.

2. For Compression-ignition Engines (Reciprocating or Rotary)

A hydrocarbon product derived from petroleum, and conforming with British Standard

2869:1970 Class A1, with the exception of cloud point. The only permissible additive treatments shall be for oxidation or corrosion control or lubricity. Additives to improve the ignition quality of the fuel are not permitted.

3. For Turbine Engines

Kerosene used by commercial aviation companies for turbo-propeller or jet engines.

4. Alcohol Fuels

Specific regulations for some groups of Historic cars may permit the use of alcohol fuels. In these cases, it is mandatory that cars using alcohol fuels also carry a symbol in the form of the letter “A” in white on a red circle of approximately 115mm diameter. This symbol should be placed adjacent to the competition number on each side of the car, and at the filling cap of the fuel tank.

5. Nitrous Oxide

Nitrous oxide is not permitted to be used in any competition under any circumstances.

6. Formula Libre

Fuel regulations for Formula Libre cars are contained in the Specific Regulations.

7. Exemptions

- For Touring Cars, only “premium unleaded” fuel is permitted.
- For Series Production Cars, only “unleaded” and “premium unleaded” fuel, as defined in paragraph 1 (above), is permitted.
- A “control fuel” may be specified for a particular series or competition. Where such control fuel is specified, such fuel must either meet the requirements of paragraph 1 (above) or be specifically approved by CAMS. It is prohibited to alter the composition of the fuel in any manner, save for the addition of a lubricant in engines not of an Otto cycle design.

8. Health Warning

All participants in motor sport are reminded that fuels, oils, lubricants and coolants are highly specialised substances.

Participants must be aware that these agents may contain substances that are extremely dangerous to one’s health if misused, inhaled or allowed to contact human skin.

Some of the contents of these fuels, oils and lubricants are suspected of having the potential to cause cancer in rare instances.

The use of petrols as a general cleaning and washing agent is a common misuse of a potentially dangerous substance.

REVOLUTION RACEGEAR **1**
FREE CALL
 Phone Orders: **1800 804 778**
 To reach your nearest REVOLUTION STORE

The Ultimate in Harnesses.

RPM RACEGEAR

RPM 5Point, 5Way. \$189

RPM 4Point, 4Way. \$139

RPM Sternum \$269

RPM 3Point, 3Way. \$129

TRW Sabelt

Sabelt 4Point, 4Way. From \$149

Sabelt 3Point, 3Way. From \$139

RPM "Octopus"2" \$498

RPM 6Point, 6Way. \$359

General Requirements (cont'd)

Schedule H Fire Extinguishers

(not applicable to Karts)

1. All racing cars of Formula Holden and Formula 2 (when competing in circuit races only) shall be required to be fitted with a fire-extinguishing system of at least 5kg extinguishant capacity, at least half of which must be placed forward of the engine, but to the rear of the foremost pick-up points of the front suspension.

The system must include a manual triggering device, operable by the driver on board or by a helper outside the vehicle, the location of which must be indicated by a letter "E" in a red circle. The direction of the outlet/s of the extinguishant is free.

The operating system must be designed so that even if the battery of the car is inoperative, the extinguisher will still function.

2. In other than circuit races, all cars mentioned in 1 (above), and in all competitions, all other Category 1 vehicles must be equipped with at least a fire extinguisher as required in 3 (below).
3. All vehicles of the 2nd, 3rd, 4th and 5th Categories in all speed events including races must be equipped with a fire extinguisher which complies with the following conditions and is properly fitted at a suitable location:
 - (i) it must comply with either of the Australian Standards 1841 (save that extinguishers which meet AS1841.2 are not permitted), 1846 or 1848, save that Halon extinguishers (1201 or 1311, including BCF) are not permitted;
 - (ii) it must be of at least 900g capacity.

The fitment of an "on-board" extinguishing system specifically authorised by CAMS or the FIA shall be acceptable as an alternative to the fitment of a separate extinguisher.

General Requirements of Automobiles (continued)

Schedule I – Safety Harnesses

(not applicable to Karts)

1. Safety harness shall comply at least with the requirements of AS 2596 (AS E35), E35, SFI or FIA Standard 8853 or 8854 and must be fitted and worn as required by vehicle and event regulations.
NOTE: For events entered on the FIA International Calendar, only harnesses complying with FIA Standard 8853 or 8854 are permitted.
2. In all vehicles in which a roll bar/cage is required to be fitted, there shall be fitted a full harness, consisting of at least a lap strap and two-strap shoulder harness, fitted with a single buckle and of which each component complies at least with the requirements of the standards noted in Item 1 (above). The harness must be securely mounted on at least three points. The shoulder straps mounted behind the driver must be above a line drawn downward from the shoulder at an angle of 40° to the horizontal. If the two shoulder straps join prior to a common mounting point then that junction shall be at least 150mm behind the driver's neck.
3. In closed cars which are not required to be fitted with a roll bar or cage, a seat belt of the full harness type (as described in 2 above) or a lap-sash type must be fitted and worn by the driver. Each component must comply at least with the standards noted in Item 1 (above).
4. In all cases of mounting the following must be observed:
 - (i) Floor mounting points must be reinforced with a plate of at least 75mm x 50mm on the underside of the body.
 - (ii) Full harness rear mounting points must be to a substantial part of the vehicle's structure, reinforced as may be appropriate.
 - (iii) On production cars, the original mounting points may be satisfactory.
5. In races all cars of 1st Category and Sports Cars (Group 2A) must be fitted with a six-strap harness which incorporates a crutch restraint. It is recommended that all cars derived from Series Production Touring cars be fitted with such six-strap harness.
6. Seat belts of cars involved in any accident must be inspected by a scrutineer at the relevant meeting. If appropriate, the vehicle log book will be endorsed with a requirement that the belts be replaced. The scrutineer at the car's next meeting must satisfy himself that the replacement has been made.

The right harness for every motor sport

- Rally/Motor Racing/Street Cars*
- Locally Manufactured to Aust. Standards AS2596 • Safe and Reliable • Over 20 years proven track record.

*RTA Approved with Engineering Certificate

Quality Endorsed Company AS 2596 Lic. No. 22 Standards Australia

DOMINION®

Dominion Webbing Products 55 Philpott Street,
 Marrickville NSW 2204. Tel: (02) 9519 1333. Fax: (02) 9516 1268

Schedule J – Roll Over Protection

NOTE: These regulations prescribe roll over protection which is acceptable for Australian National and lesser events. The FIA regulations apply to international events, copies of which are available from the CAMS National Office on request.

Roll over protection which complies with the FIA regulations is acceptable in Australian competitions.

1. ROLL OVER PROTECTION IS REQUIRED AS FOLLOWS:

- 1.1 Races: all cars except:
 - (i) bodily unmodified, fixed-roof closed cars in races other than International and National Level; and
 - (ii) those in competitions exclusively for 5th Category (Historic) Cars other than Group N.
- 1.2 Truck Races: as specified in Appendix A to the Truck Formula.
- 1.3 State Level and above Speed Events: all cars, except Touring Cars, cars of the 5th Category, or cars which are road-registered.
- 1.4 Single- and Multi-car Speed Events: not required.
- 1.5 Off Road Events: as specified in vehicle regulations for Group 4F.
- 1.6 Rallies: all cars in International, Australian Championship and Special Stage events.
- 1.7 Other Events: as specified in the relevant Supplementary Regulations.
- 1.8 Karts: not required.

- (iv) in closed cars, be placed as near as practical to the roof in order to limit crushing; and
- (v) in 1st Category (Racing) Cars, be constructed so that the driver's helmet is prevented from passing between the hoop bars to the extent that the helmet is visible at the rear of the hoop when viewed from the side.
- 2.3 (i) Principal main hoop braces shall be straight; save that in closed cars where the diameter of a brace is not less than 45mm it may be bent to conform to an adjacent coachwork profile, eg, the roof line.
- (ii) Any transverse diagonal brace shall ideally be attached to the hoop from the bottom of one side to the top of the other side. See Section 3 for acceptable alternatives.
- (iii) Longitudinal brace/s shall be attached to the upper portion of the hoop on each side of the car where applicable, and shall extend towards the rear of the car as far as practicable.
- (iv) On 1st Category (Racing) Cars and open Sports Cars, it may be more appropriate for longitudinal braces to be forward of the main hoop rather than rearward. Such configurations may be specifically approved by CAMS, on application; subject to accessibility of the driver not being impaired.
- 2.4 Front seat access must not suffer interference by the fitting of roll over protection, and no encroachment is permitted upon the space reserved for the driver and any front seat passenger.
- 2.5 Rear passenger space may be encroached upon by the elements of roll over protection, and elements may pass through rear seat upholstery.

2. CONFIGURATION

- 2.1 The general design and form of the protection shall be as shown in Section 3 below.
- 2.2 The main hoop shall be placed behind and above the driver's head from one side of the car to the other and, with the driver seated in the normal position, the hoop shall:
 - (i) be not less than 50mm above the driver's helmet;
 - (ii) in conjunction with the vehicle's structure, not leave unprotected any part of the driver's profile, including shoulders, when viewed from the front or rear;
 - (iii) not overhang, but be within, 150mm of the driver's helmet;

Schedule J – Roll Over Protection (continued)

| 3. FORMS OF ACCEPTABLE ROLL OVER PROTECTION | | | |
|---|----------------------------|--|--|
| Type | Description | Vehicle Application | Remarks |
| 1 | Solo roll bar | 1st Category Cars Open sports cars only for other than speed events | Two 25mm dia. x 1.5mm gauge longitudinal braces or one brace of identical size to the hoop |
| 2 | Full width roll bar | Light weight (700kg) closed cars and open sports cars | Acceptable only for other than speed events and races |
| 3 | Full width braced roll bar | Minimum acceptable in speed events for closed cars under 1150kg and open sports cars | |
| 4 | Half cage | Recommended for closed cars under 1150kg. Minimum requirement for closed cars over 1150kg. Recommended for open sports cars. Minimum acceptable for all open cars in off road events. | Strut MS may be RN, RQ or SP |
| 5 | Full cage | Recommended for closed cars over 1150kg | Strut MS may be RN, RQ or SP |

4. MATERIAL

4.1 Mild Steel: All hoops and braces shall be round in section; of minimum sizes set out below; and of steel tube conforming to Australian Standard 1450 – 1983 "Steel Tubes for Mechanical Purposes". The material shall have a minimum yield strength of 250 MPa.

4.2 Alternative Materials: Acceptable aluminium alloys are: B6351 T5 B6061 T6
Roll over protection using such alternative material may be fabricated only by firms or persons meeting the requirements as notified by CAMS from time to time.
All protection structures manufactured

STANDARD REQUIREMENTS

AIRCRAFT ENGINEERING PTY LTD

We carry 4130N chrome moly tubing, sheet, rod, streamline tubing and CDW 350 tubing. Our tube in Reynolds ranges from 1/4" x .035 through to 2-1/4" x .100 and our sizes in 4130N range from 1/4" x .035 through to 2-1/2" x .250 TIG welding services also available

Suit Drag, Speedway, Rally and Touring Cars

16 Tradelink Road, Browns Plains QLD 4118
PH: (07) 3800 7869 FAX: (07) 3800 7507

Queensland Distributors

REYNOLDS
"531"
TUBING



**P•E•R•F•O•R•M•A•N•C•E
P•R•O•D•U•C•T•S**

**61 Bennet Street
Dandenong VIC 3175
Tel: 03 9791 8622
Fax: 03 9791 8005**

ROLL CAGES



- 4 POINT
- 6 POINT
- CUSTOM MADE TO INDIVIDUAL REQUIREMENTS
- STEEL & ALLOY TO CAMS AND FIA REQUIREMENTS

**ROLL CAGES, ROLL BARS, UTE BARS, TRADESMAN RACKS,
GENERAL STEEL & ALUMINIUM FABRICATING**

STANDARD REQUIREMENTS

General Requirements of Automobiles (continued)

Schedule J – Roll Over Protection (continued)

from aluminium alloy must have a plate affixed by welding to the driver's side rear brace of the main hoop, at a distance of not more than 200mm from the main hoop, and in a position to enable the plate to be viewed from outside the coachwork or through a window, which shall indicate the name of the manufacturer of the structure, the vehicle for which it was designed and the month and year of manufacture.

- 4.3 Acceptable alternative material sections corresponding to prescribed steel sections are:

| Mild Steel | Aluminium Alloy Alternative |
|------------|-----------------------------|
| 25 x 1.5mm | 30 x 2.0mm |
| 30 x 1.5mm | 38 x 2.5mm |
| 38 x 2.5mm | |
| 45 x 2.5mm | 45 x 3.0mm |
| 50 x 2.5mm | 50 x 3.0mm |

- 4.4 Bolts and nuts shall be, at least:
- (i) if of imperial size, not inferior to Grade 5 (55 ton/in²) hexagon head high tensile units to AS2465 or 90 ton/in² cap screws to BS2470, or
- (ii) if of metric size, not inferior to Class 8.8 (830 MPa) hexagon head high tensile bolts to AS1110 or 1250 MPa cap screws to AS1420 and nuts not inferior to Class 8 to AS1112.

In all cases, the use of self-locking nuts is recommended.

- 4.5 Pins for removable connections (see Figure 4) shall be of the same specification as bolts.

5. FABRICATION

- 5.1 Continuous lengths of tubing shall be used for main hoops and for braces. All bends shall be smooth and without evidence of crimping, wall failure or significant weakening. Any reduction in dimensions of the section at a bend shall not exceed 10 percent of the original dimension.

- 5.2 All welds should encompass the full circumference of the joint and should be of the highest quality possible with full penetration; the use of MIG or TIG welding processes is preferred.

- 5.3 For welding of aluminium alloy roll over protection, filler rod with five percent magnesium content must be used.

- 5.4 Any hole drilled in the main hoop shall conform with Figure 3 (page 6-22). The wall thickness of the inserted tube shall be at least that of the drilled tube.

- 5.5 Any hole drilled in a brace of less than 3mm wall thickness shall conform with Figure 3 (page 6-22). The wall thickness of any inserted tube shall be at least that of the drilled tube.

Roll Bars

Steel & alloy roll cages to CAMS & FIA specifications.

Specialising in all forms of race car fabrication & preparation.

For quality workmanship & professional service contact

Andrew Brown

Fuel Tanks

Race car fuel tanks & custom-made fuel bladders.



**Factory 17B Brougham St.
Eltham. Vic. 3095.
Tel/Fax: 03 9431 0433**

Schedule J – Roll Over Protection (continued)

6. REMOVABLE CONNECTIONS

In cases where removable connections are used in roll over protection they must comply with the following:

- 6.1 twin lug connection with pin/s working under double shear (see Figure 4);
- 6.2 tapered connection (see Figure 5);
- 6.3 tee clamp connection (see Figure 6); or
- 6.4 muff connection (see Figure 7).

7. MOUNTINGS

- 7.1 **Mounting Plates:** where the mountings are not part of the car's structure, mounting plates of at least the following dimensions, affixed to a structural portion of the car, are required:

| | |
|----------------------------|-------------|
| Thickness: Steel | 4.7mm |
| Aluminium | 6.0mm |
| Area: Lower: | 100 x 45mm |
| Upper: | |
| Where the car's weight is: | |
| • less than 700kg: | 100 x 65mm |
| • between 700-1150kg: | 100 x 75mm |
| • greater than 1150kg: | 100 x 100mm |

- 7.2 **Bolts:** at least two of 10mm diameter or three of 8mm diameter, or the approved equivalent, in each plate.

- 7.3 **Chassis Reinforcement:** where the roll bar rests on a boxed section the latter must be locally reinforced. A recommended method is shown in Figure 2.

7.4 Road Registered Closed Production Vehicles:

- (i) The main hoop may be attached using at least four safety belt mounting points provided by the vehicle manufacturer, provided that:
- the mounting points are within 75mm of the centre line of the hoop tube, and
 - the intermediate mounting plates comply with Item 7.1 (above) for upper plates, and
 - the main hoop extends to the floor of the car and the structure sits on feet of at least 100 x 100mm.
- (ii) The braces may utilise as attachment points the rear safety belt mounting points provided by the vehicle manufacturer.
- NOTE:** Roll over protection fitted in this manner may render a vehicle unregistrable in some states.

8. DIMENSIONS

- 8.1 For the main hoop the minimum sectional dimensions are:

| Application | Tube Section (Steel) |
|--|----------------------|
| • Main hoop less than 610mm x 380mm | : 30 x 1.5mm |
| • Off Road Vehicles of Class 1, 2, 3, 6 or 9 | : 38 x 2.5mm |
| • All other applications | : 45 x 2.5mm |

- 8.2 For secondary hoops and braces the minimum sectional dimensions are:

STEEL ROLL CAGES TO FIA SPEC.
BATHURST STYLE DROP TANK
SEAT BELTS, ALLOY WELDING
TUBE BENDING
CHEAP FREIGHT

FIRE SYSTEMS

- FT3 FUEL TANKS
- DRY BREAK FUEL FILLERS
- GENERAL FUEL TANKS

Phone (02) 9743 7005

Fax (02) 9743 7610

22 Carlingford Street
Regents Park NSW 2413



BOND ROLL BARS

General Requirements of Automobiles (continued)

Schedule J – Roll Over Protection (continued)

| Roll Bar Type | Tube Section (Steel) |
|------------------------|-------------------------------|
| • Types 1 and 2 | : 25 x 1.5mm |
| • Types 3, 4 and 5 | : 30 x 1.5mm |
| • In cars up to 1150kg | : 38 x 2.5mm |
| • In cars over 1150kg | : 38 x 2.5mm or 45 x 1.5mm |

9. IMPLEMENTATION

Existing cars registered with CAMS prior to 31 December, 1992, may continue in competition provided they remain in conformity with the regulations which were in force up to that date.

10. VARIATIONS

These regulations serve to specify a minimum design standard only. Alternative configurations will be considered by CAMS on individual application and may be specifically approved, subject to:

- the structure meeting the requirement of Article 2 - Configuration
- the design of the structure being specifically approved by CAMS National Office prior to fitment in the car
- the structure meeting specific performance criteria which shall be demonstrated by either calculation or by demonstration

- the completion of a CAMS Roll Over Protection Certificate form, available from CAMS National Office
- the structure being identified with a plate, supplied by CAMS.

Upon completion of this form by the manufacturer and the engineer, the form must be approved and stamped accordingly by CAMS National Office and a copy must be presented on request to the relevant official of a meeting.

11. NON-COMPLYING ROLL OVER PROTECTION

Roll bars which do not comply with these regulations or are not otherwise specifically approved by CAMS are prohibited in all levels of competition, unless approval is granted by the Stewards of the Meeting.

General Requirements of Automobiles (continued)

Schedule J – Roll Over Protection (continued)

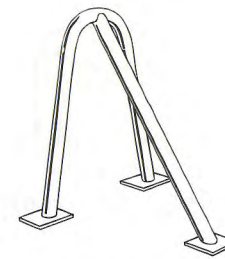

Type 1 Solo Roll Bar



Type 2 Full Width Roll Bar

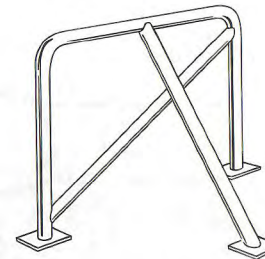

Type 3 Full Width Braced Roll Bar

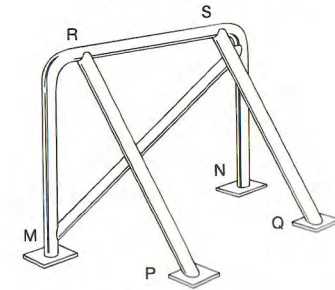

Type 4 Half Cage

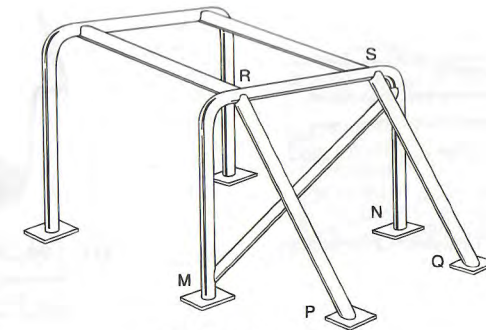

Type 5 Full Cage

ROLL BARS

Steel and Alloy Roll Cages To CAMS and Specs

CDW & CDS to FIA 1994 Spec
Reynolds 531 Tube
Chrome Moly 4130
B6351 T5 or B6061 T6 Alloy

Specialists in Roll Cages for competition and non-competition use. Alloy Welding and Tube Bending.

FUEL TANKS

Race Car Fuel Tanks. Bathurst Style Alloy Drop Tanks.



47 Holloway Drive, Bayswater 3153

A.C.N. 006 404 020

Phone: (03) 9762 8722

Fax: (03) 9762 9829



RACEtech

HIGH TENSILE STEEL TUBE

Stockists of TUBE • SHEET • SQUARE • RECTANGLE • STREAMLINE

British International Trading, 34 Bearing Rd, Seven Hills NSW 2147 Ph (02) 9674 4566 Fax (02) 9674 3854
For more information see our listing under Roll Bars/Cages or Steel Suppliers in the Goods & Services Directory

Schedule J – Roll Over Protection (continued)



Fig 1 Bolt Identification

UNIFIED
Grade 5 Head Marking
UTS 55 ton/in²
Bolt to AS 2465

METRIC
Class 8.8 Head Marking
UTS 830 MPa
Bolt to AS 1110

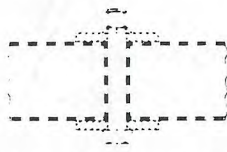

Fig 2 Reinforcing a Box Section

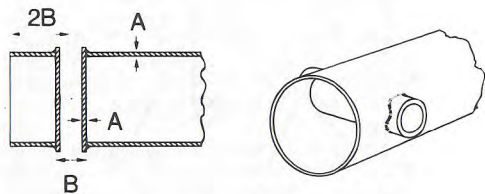

Fig 3 Sleeving a Hoop or Brace

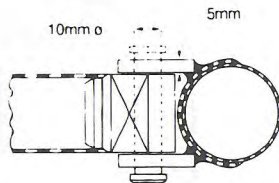

Fig 4 Twin Lug Connection

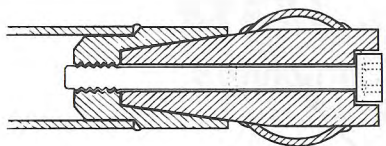

Fig 5 Tapered Connection

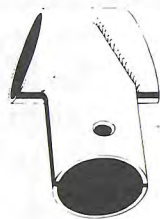

Fig 6 Tee Clamp Connection

Material & Wall Thickness
Mild Steel: 3.0mm Min
Aluminium: 4.2mm Min

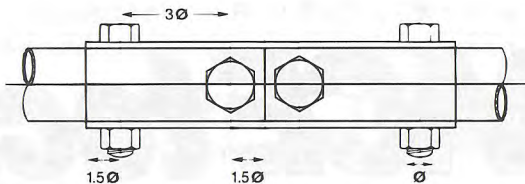

Fig 7 Muff Connection

Minimum Bolt Diameter
Tube <40mm OD: ø = 12mm
Tube 40-50mm OD: ø = 14mm
Tube >50mm OD: ø = 16mm

Schedule K – Markings on Automobiles

1. NUMBERS

1.1 Competition numbers carried on automobiles in accordance with Rule 147 in speed competitions shall comply with the following requirements:

- (i) the number shall be carried in such manner that in the opinion of the Chief Timekeeper it is clearly visible from both sides and the front of the automobile;
- (ii) On 1st Category cars, the numbers must, if physically possible, be displayed on the end plates of any rear wing; failing which they must be displayed on the body alongside the cockpit, totally on a vertical surface. On cars of 2nd and 3rd Category, the number must be displayed on the front doors;
- (iii) the number shall be either white on a black background or black on a white background. The background for the number must be either a disc or rectangle in a colour contrasting with the colour of the coachwork.

1.2 Numbers must be of the typestyle known as "Helvetica Bold":



- (i) on 1st Category and Sports Cars, the minimum height of the figure shall be 230mm and the minimum width of the line in each figure at least 40mm. The background shall be at least 450mm wide by 310mm high (see Figure 8);
- (ii) on all other cars, each figure must be at least 280mm in height, and the width of the line in each figure must be at least 50mm (see Figure 8).

1.3 No part of any numeral shall be closer than 40mm to any part of the adjoining numeral, or to any part of the edge of the background; and no part of the competition number shall be closer than 160mm to any part of other signs permitted hereunder.

1.4 Above or below the background, a surface having the same width as the background (in any case at least 450mm wide on 1st Category and Sports Cars and 500mm on other cars), and of a height of at least 120mm, shall be left free of advertising to be used at the discretion of CAMS, which may use it for advertising purposes, or which may delegate to the organisers authority to use that space. On cars on which such an area is not available due to coachwork limitations the competitors shall keep free of any advertising an equivalent surface in the immediate vicinity of the background (see Figure 8).

1.5 Competition number "1" is reserved exclusively for the current Australian champion driver in each applicable category. The champion driver

may elect not to use number "1", and in such eventuality it would be withheld for the appropriate period. In Australian Rally Championship events, the current Australian Rally Champion driver may use a yellow background where the relevant Regulations stipulate a white background. The exclusive use of the number "1" by the current champion will not apply to rallies.

1.6 "Zero" alone is not permitted to be used as a number.

2. PROVISIONAL LICENCE HOLDERS

In any race automobiles driven by the holders of Provisional Licences for Drivers shall carry, mounted so that they are clearly visible from the rear of the automobile at a distance of 100m in daylight, a plate carrying the capital "P", in red on a white background, basically similar in size and design to those approved by Australian authorities for civil probationary or provisional drivers.

3. OTHER SIGNS

3.1 Signs or advertisements displayed upon automobiles in accordance with NCR 155 shall comply with the following requirements:

- (i) No sign or advertisement shall be permitted on any windscreen, side or rear window. Notwithstanding the provisions of this subparagraph, it shall be permitted to display signs
 - on the top of the windscreen on a background free as to colour and depth, subject to the lettering and devices being placed within the upper 200mm of the windscreen surface; and
 - on the rear window of closed cars on a background strip located within the upper 85mm of the top of the glass, provided that it does not interfere with the visibility of the driver;
 - the sport regulations for a CAMS-approved championship, cup, challenge etc may make other requirements.

(ii) No sign or advertisement shall be permitted within 100mm of the background area of a competition number, or within 160mm of the number itself (see figure 8).

3.2 No sign shall be permitted to contain any Arabic numerals, unless such sign comprises the name of a club affiliated with CAMS; or forms part of a registered trade mark; or being a telephone number is displayed on a rearward facing coachwork panel. In the case of cars competing in road events, Arabic numerals may be displayed subject to them being not greater than 100mm in height, not located on either front door of the car, and otherwise complying with the requirements of this Schedule.

3.3 No sign or advertisement shall be permitted to be indecent or in breach of good taste; the Clerk of Course at any meeting shall be autho-

Schedule K – Markings on Automobiles (continued)

- rised to refer to the Stewards of the Meeting any sign which he deems to be contrary to the requirements of this paragraph and the stewards' decision thereon shall be final in respect of that meeting.
- 3.4 Registration labels and official number plates shall not be deemed to be advertising with regard to this Schedule.
 - 3.5 In International competitions, there shall be displayed on both front mudguards a facsimile of the national flag of the driver/s, as well as the names of the driver/s. The minimum height of each flag and name shall be 40mm.
 - 3.6 In each of the Sports Sedan, Production Car, GT Production and Touring Car Championships, the surname of each driver must be displayed on the lower edge of each rear-most side window and the rear window, in letters of uniform style, 100mm height (side windows) and 50mm height (rear window), white in colour, and without background, using a capital for the first letter of the name, and lower case for all other letters.
The typestyle must be **Helvetica Bold**.
In non-championship races for closed cars, such display is optional, but if used, must comply with this Regulation.
 - 3.7 On vehicles which conform to the Truck Formula, including Utility Trucks, the area of the turret/door frame immediately above the side glass line may be used for the entrant's and/or driver's name subject to the following maximum dimensions:
 - Utility Trucks: 50 x 600mm
 - All other trucks: 50 x 600mm
 - 3.8 The original style of paintwork and livery is encouraged.
The name of the driver may be shown on the vehicle, appearing once on either side in a position below the window line, in a size not larger than 40mm by 300mm.
A club badge, of an acceptable motoring club, can appear on the vehicle. Each badge

must be not larger than 150mm by 100mm and must be placed below the window line. Only two such badges are permitted.
The territory of origin of the driver may be shown on the vehicle. Each sign must be not larger than 100mm by 150mm and must be placed below the window line. Only two such signs are permitted, one on each side of the vehicle.
No other advertising material or sign is permitted unless evident in the applicable group period. (See relevant Group Articles, Section 8.)

4. LETTERING

The lettering of all numerals and letters in all signs referred to in this Schedule and these Rules shall be carried out in a neat, regular and professional manner. Scrutineers may order the relettering of any sign or part of a sign etc, which in their opinion fails to comply with the requirements of this paragraph.

5. TRADE MARKS

5.1 Arabic numerals where they form part of a registered trade mark may be used subject to the foregoing, and the following additional requirements:

- (i) On the sides of the car no part of the numeral shall come within 120mm of a competition number;
 - (ii) shall be no larger than and of a colour contrasting with the competition number.
- 5.2 The above notwithstanding, the Chief Timekeeper may direct the removal of such numbers from the side of the car presented to the timing box, if in his opinion the presence of the numerals could prejudice the operation of the timing and lap scoring.

6. SPONSOR REQUIREMENT

6.1 In the absence of the written approval of the Board or the Executive, no sponsor and/or promoter may make any requirement or prohibition

Schedule K – Markings on Automobiles (continued)

- regarding signs on vehicles in races which is binding on entrants.
- 6.2 In National Championship rallies, an area 500mm wide x 520mm high, unencumbered and white in colour, must be reserved on each front door for the organisers' signs.
 - 6.3 Organisers may make no other requirements as to signs on the sides of cars.
 7. VARIATION
Notwithstanding the requirements of this part

of Appendix C, the Chief Executive Officer of CAMS shall have discretion in approving any sign not in conformity therewith, provided it is deemed to be a public service and/or beneficial to the sport; and in respect of numbers, on condition that artwork of the proposal is submitted, and if permitted, that a fee of \$500 be paid annually. All such variations must be noted in the subject vehicle's log book.

Schedule L – Vehicle Log Books

1. The production of a properly entered vehicle log book issued by CAMS is required by Rule 150. Failure to present such vehicle log book when the relevant vehicle is presented for scrutineering may involve exclusion of the vehicle concerned from the relevant competition. The Chief Steward may, however, permit the vehicle to practice upon payment of a fine of \$40 (see Appendix R) and completion of a Statutory Declaration that the vehicle is subject to a current and valid log book. Should the relevant log book not be produced prior to the competition, the vehicle will not be permitted to compete save upon the explicit authority of the stewards, subject to whatever conditions they may impose. Failure to produce the log book may result in the competitor/s being charged with an offence against the NCR, including NCR 183 (ii), (iii) and (xii).

differ from the specifications laid down in the relevant vehicle's homologation or Recognition Certificate, or (in the event that such certificate is not available for whatever reason) from the specifications laid down for the make and model concerned by the relevant manufacturer (3rd Category vehicles only); or
(ii) the automobile is found, upon examination by a scrutineer, to differ from the specifications stated in the vehicle log book; and the presentation of the automobile for scrutineering under either of the contingencies foreseen in subparagraphs (i) or (ii) of this paragraph shall be deemed a prima facie breach of these Rules, and punishable accordingly.

2. The vehicle log book shall be issued by CAMS. Only one log book shall be issued for each vehicle (other than by way of extension or replacement), and the possession of two log books for any vehicle at one time shall be deemed an offence against these Rules.
3. CAMS will issue a vehicle log book only upon written application signed by the bona fide owner of the relevant automobile, and upon payment by such owner of a fee as stated in Appendix R to these Rules.
4. Notwithstanding the issue by CAMS of such vehicle log book the said log book shall be deemed invalid if:
 - (i) the specification therein, or any of them, are found upon examination by a scrutineer to

5. Amendments to the vehicle log book shall be made only by CAMS and upon the completion of a written application by the bona fide legal owner of the automobile concerned.
6. Any alteration to the specifications of an automobile, or any change in its bona fide legal ownership, shall necessarily involve the return of the relevant vehicle log book to CAMS for the recording of each alteration or change.
7. Entries in log books may be made only by the Chief Scrutineer or his deputy, a steward of the meeting, a person specifically appointed by CAMS to the task of scrutineering for eligibility, or a permanent employee of CAMS. Such endorsements may be cancelled or noted as having been complied with, only by any of the above persons.
8. Any person or body competing, or offering or attempting to compete, in any competition for which a valid vehicle log book is required while not in possession of a relevant and valid vehicle log book shall be liable to penalties under these Rules; or having so competed shall be excluded from the results of such competition without prejudice to the infliction upon him of further penalties under these Rules.
9. Any official of a meeting who, under any pretext, permits the competition of any automobile known by him to be ineligible, or

Figure 8

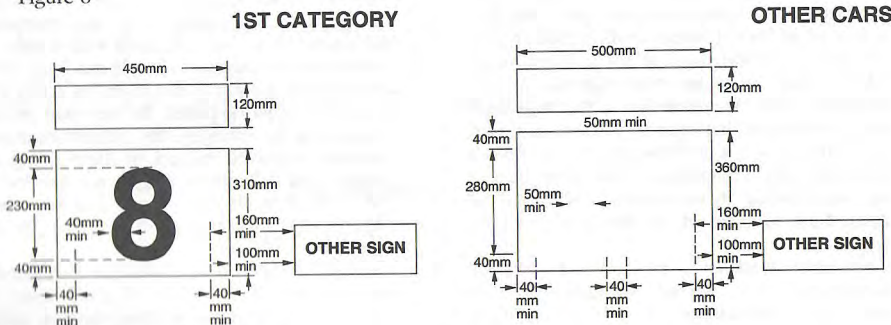

Schedule L – Vehicle Log Books

- reported to him by the relevant officials as being ineligible, shall be liable to serious penalties under these Rules, without prejudice to the infliction of further penalties upon the entrant and/or driver of such automobiles (see Rules 169 (x), 172 (iv), 177, 183 (ii), 183 (iv)).
10. Measurements taken by scrutineers approved by CAMS shall be deemed to be accurate, and no protest shall lie in respect of the methods employed by such scrutineers in taking such measurements, scrutineers being Judges of Fact in this context (see Rule 181 (i) (c)).

EXPLANATORY NOTE: Save for vehicles of the 5th Category, the log book serves as an identification for the car, and a means of communication from one competition to the next. It also records the vehicle's ownership. The log book is *not prima facie* evidence of the car's eligibility for a particular category or group, nor is it a certificate of compliance. Any vehicle may compete in any category or group for which it is eligible, and is thus determined at the time of scrutiny of the vehicle.

When an automobile is entered in a competition for a class or category other than that noted in the log book it shall comply with the conditions for that class or category.

Schedule M – Scatter Shields

1. APPLICATION

- A scatter shield complying with the specification below must be fitted to:
- (i) Front-engined Sports Sedans which have undergone an engine change, or which are fitted with a transverse engine transmission assembly.
 - (ii) Front-engined Sports Cars and front-engined Category 1 cars, in which a derangement of the clutch-flywheel assembly could pose a hazard to the driver.
Excepted from the above requirements (i) and (ii) are those cars upon which the entire clutch-flywheel housing is, in plan view, forward of all parts of the driver's body when he is seated normally in the car.
 - (iii) Any rear- or mid-engined Category 1 or 2 car:
 - in which derangement of the clutch-flywheel assembly could present a hazard to the driver; or
 - which is fitted with a transverse engine transmission assembly; or
 - on which the clutch-flywheel assembly extends to within 250mm of the rear of the driver's seat, when such seat is at the rearmost extremity of adjustment.

NOTE: Historic cars when competing in events exclusively for such cars are exempted from this requirement.

2. SPECIFICATION

- 2.1 The shield must be so fitted as to minimise the risk of injury in case of flywheel and/or clutch failure. It must be of safe construction.
- 2.2 The shield must be fitted under the floor or, in appropriate cases, in the engine compartment. It must not rely on floor or toeboard for strength and it must be securely mounted.
- 2.3 The shield must be of sufficient width and length to protect the occupant of the driver's seat and should encompass at least 140° above the horizontal.
- 2.4 The shield must be of a thickness of:
 - 6mm if mild steel plate;
 - 3mm if TIA steel plate;
 - 6mm if Alcoa aluminium alloy A5083H321.
 Specifications of alternative materials may be submitted to CAMS for evaluation before installation or manufacture.

3. ALTERNATIVES

A scatter shield may be dispensed with on vehicles where the construction of the flywheel/clutch housing is such that it meets or exceeds the requirements herein, eg, a housing fabricated from mild steel plate of 6mm thickness.

Schedule N – Fuel Tanks and Refuelling

Part 1 – Fuel Tanks (State Level and Above Race Meetings Only)

1. 1ST CATEGORY CARS

- 1.1 It is compulsory for all cars of Formula Holden, in championship races all cars of Formula 2, and all cars with a fuel capacity in excess of 50 litres, to be equipped with fuel tanks either fitted with a CAMS-approved foam by a CAMS-approved fitter, or fitted with a safety-type fuel tank as approved by the FIA.
- 1.2 Tank fillers and caps must not protrude beyond the coachwork. The caps must be designed in such a way as to ensure an efficient locking action which reduces the risk of an external opening following a crash impact or incomplete locking after refuelling. Fillers must be placed away from points which are vulnerable in case of a crash. The air vents must be located at least 250mm to the rear of the cockpit.
- 1.3 From a date to be advised, it will be compulsory for all cars of Formula 2 and all cars with a fuel capacity in excess of 50 litres to be fitted with a safety-type fuel tank, of a type as will be specified by FIA and CAMS.
- 1.4 From a date to be advised, it will be required that that part of the structure surrounding the fuel tank which is in direct contact with the air stream must include an aluminium sheet of a to-be-determined thickness, tensile strength and elongation.
- 1.5 All Formula 2 cars first registered with CAMS after 1 January, 1977, and all those in which the fuel tank is within 100mm of the outside surface of the car, shall be fitted with a crushable structure.
- 1.6 It is recommended that car owners adopt as a guide the following specifications for the fuel tank surround, and incorporate this in their cars:

| | |
|--------------------|---------------------------|
| Thickness | 1.5mm |
| Material | Aluminium magnesium alloy |
| Tensile strength | 215 MPa |
| Minimum elongation | 5% |

2. CARS OF THE 2ND, 3RD AND 4TH CATEGORIES

- 2.1 Cars of the 2nd Category must be fitted with fuel tanks of capacity no greater than specified in 2.6 below. The fuel tanks must be fitted with antispray foam in conformity with CAMS Standard or the tanks must be of a safety type approved by CAMS and/or FIA. In races of less than 30 minutes' duration, road-registered cars need not comply with this requirement.
- 2.2 All vehicles not previously registered with CAMS or of a model for which a log book has

- not previously been issued, must be fitted with fuel tanks of capacity no greater than specified in 2.6 below.
- 2.3 In 3rd Category vehicles it is permitted to replace original fuel tanks with FIA bladder tanks or such tanks as CAMS may approve provided the fuel capacity does not exceed that specified in 2.6 below.
- 2.4 Should "dry-break" fuel couplings be fitted then a FIA- or CAMS-approved tank is required (see 2.5 below for exception). The fuel filling port must then be relocated and in such relocation:
 - (i) the original fuel port/s shall be rendered inoperative;
 - (ii) the valve receiver mounting must be installed in the appropriate external panel in such a way as to prevent entry of fuel into the boot compartment in the event of spillage;
 - (iii) a flexible connection between the valve receiver mounting and the top of the fuel tank is permitted.

See Part 2 for further information regarding refuelling with dry-break couplings.

- 2.5 If dry-break fuel couplings are fitted to Series Production Cars equipped with standard fuel tanks as supplied by the manufacturer and the tank remains unmodified in all other respects (including baffling, foam filling and modifications to the filler neck or venting stem), any consequential increase in fuel capacity will be acceptable. However, the fitment of the refuelling and vent bottle orifices must be as close as practical to the fuel tank; the size of the refuelling pipe from the rear of the dry-break coupling to the original filler neck of the fuel tank must be no greater than that of the OD of the exit of the dry-break bulb; and the route of the filler and vent pipes from the dry-break bulbs to the fuel tank must be as short as practical.
- 2.6 The maximum capacity of fuel tanks fitted to cars of the 2nd, 3rd and 4th Categories, except provided above, shall be:

| | |
|-------------|------------|
| Up to 700cc | 60 litres |
| 700-1000cc | 70 litres |
| 1001-1300cc | 80 litres |
| 1301-1600cc | 90 litres |
| 1601-2000cc | 100 litres |
| 2001-2500cc | 110 litres |
| Over 2500cc | 120 litres |

 (1 gallon = 4.55 litres, 120 litres = 26.3 gallons)
- 2.7 (i) Cars of the 3rd and 4th Categories competing in races scheduled to extend more than 30 minutes and not fitted with a "safety

tank” must have fitted to their fuel tank (by an approved fitter) such anti-spray foam as specified by CAMS.

- (ii) Car owners are reminded that, at some future date, such foam may be required in all cars.
- (iii) The foam to be used is that produced for this purpose and marketed as Meracel ME 015 to ME 030.

3. GENERAL

- 3.1 The requirements of this Schedule N do not apply to Club or Multi-club Level race meetings, nor to cars participating in races exclusively for Production Cars.
- 3.2 Cars first registered with CAMS after 1 January, 1977, are not permitted to have fuel tanks forming part of the stressed structure of the car.
- 3.3 In all races, refuelling in pit lane may be undertaken only under the conditions prescribed in Part 2 hereof.
- 3.4 **NOTE:** Refer also to relevant technical regulations for the category/class.

**Schedule N – Fuel Tanks and Refuelling
Part 2 – Refuelling in Pit Lane**

1. GENERAL

- 1.1 For any refuelling undertaken in pit lane, during any testing, practice, qualifying or race, the following procedures must be adopted, unless Supplementary Regulations provide otherwise.
- 1.2 Any refuelling in a pit or paddock area not utilising these procedures must be undertaken either with a vehicle totally within a pit garage or in the area of the paddock specifically designated for the purpose of refuelling; and must be completed with the engine turned off.
- 1.3 Under no circumstances will refuelling be permitted on the circuit.
- 1.4 When event regulations allow the use of any alternative refuelling equipment, those regulations shall prescribe all relevant conditions, including capacity of permitted refuelling containers and the requirements for delivery hose(s).
- 1.5 The regulations regarding the use of overhead rigs are compatible with FIA requirements and are thus acceptable for international events. The use of churns in International events must be authorised in the event Supplementary Regulations.

2. SAFETY

- 2.1 **Area:** The area of the pit garage in which the fuel reservoirs are situated must be adequately ventilated and have unimpeded access from front and rear of the pit garage. A maximum of two fire extinguishers complying with AS 1841 of a capacity of at least 9kg K90 or Monnex substance must be available for use in each pit. The area must be clean and free of potentially flammable materials e.g. paper, rags, oily fabrics etc.
- 2.2 **Pit Crew:** As prescribed in Race Meeting Standing Regulations, the maximum number of attendants handling refuelling related procedures will be four, their designated tasks will be as follows:
 Fire attendant;
 Vent bottle attendant;
 Two churn attendants;
 or
 Fire attendant;
 Vent bottle attendant;
 One hose attendant;
 One rig cut off valve attendant.

All attendants will be required to be attired in the same minimum standards of protective clothing as are required for drivers in National races (see Schedule D, Article 3 (1), (2), (3) and (4)). Balaclavas must be worn and any resultant exposed areas (e.g. eyes) must be covered to minimise risk of injury from flash fire burns (e.g. by goggles). The wearing of a

full face helmet is recommended in addition to the above.

Any wheel attendants whose tasks place them within 1 metre of a fuel or vent valve on a vehicle will be required to wear clothing as listed in above for fuel attendants.

For the entire time of a pit stop during which any refuelling operation is undertaken, it will be compulsory for the Fire Attendant to be ready to attend to any fire which may occur. The Fire Attendant must stand near the car and the overhead rig, poised with the extinguisher ready to operate.

- 2.3 **Emergency Cut-Off Valve:** It will be compulsory for any refuelling operation which incorporates an overhead rig that the rig be equipped with a ball-cock or similar fast action valve ceases the flow of fuel and which must work on the "dead man" principle. The emergency cut-off valve attendant may hold the valve open only during the refuelling operations. When pressure on the handle of the cut-off valve is released, the valve must immediately close, stopping the flow of fuel from the reservoir.

2.4 Approval of Installations and Equipment:

All installations and equipment must be specifically approved by the Chief Scrutineer of the Meeting or his nominee prior to any competition during which refuelling is permitted in pit lane. Event supplementary regulations will provide further details of times etc for the inspection.

- 2.5 **Earthing:** During any refuelling operation, it is strongly recommended that vehicles to be electrically connected to earth, viz:
 - (i) Each pit is equipped with two aircraft type grounding connections. Vehicles must be equipped with a suitable terminal to which one of these connections may be attached.
 - (ii) The refuelling system (including tower, tank, hose, nozzle, valves and vent bottle) be connected to one of the above grounding connections for the entire duration of the race.
 - (iii) The car is connected, at least momentarily, to the other grounding connection as soon as it stops in the pit.
 - (iv) No fuel hose connection (either the fill or vent bottle) be made unless conditions (ii) and (iii) have been fulfilled.

- 2.6 **Vehicle movement:** The vehicle must be stationary at all times during refuelling.

3. FUEL TANKS (VEHICLES)

Refer to Schedule N (Part 1) and the relevant Technical Regulations for requirements of fuel tanks.

STANDARD REQUIREMENTS

RACING FUEL CELLS

**FIA, NASCAR APPROVED
BLADDER TANKS.**

FUEL

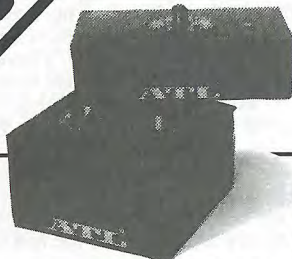

LOW COST "SAVER CELL"®
Standard Sizes:
15.1., 20.1., 30.1., 45.1., 60.1., 90.1., 120.1., 170.1.

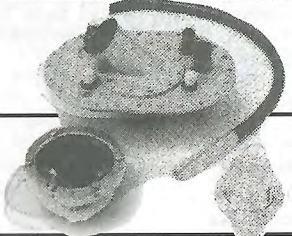

CUSTOM SHAPES FROM DU PONT KEVLAR®
• Lightweight • High strength • Flexible
• Any capacity or shape ®Kevlar is a Du Pont T.M.

ATL: Fuel Cell Suppliers to Williams,
Arrows, Ferrari, Ligier, Tyrell,
McLaren, Lola, Benetton, etc...

ATL® COMPETITION EQUIPMENT Automobilia Australia Pty Ltd
154-156 Clarence Street Sydney NSW 2000
Tel: (02) 9299 2248 Fax: (02) 9290 2446

STANDARD REQUIREMENTS

FUEL

4. **STANDARD COUPLING**

All refuelling operations must be carried out utilising a dry-break system. A dry-break system is deemed to consist of two separate units, the receiving unit and the probe unit together with the associated hoses, valves etc. The general design of the receiving unit and probe unit is included at Diagram 1.

A male probe unit shall be fitted to each churn or to the refuelling hose (if using a refuelling rig).

The receiving units shall be fitted to the vehicle, under the conditions listed in the technical regulations for the relevant category.

It is permitted to only use one receiving valve to permit the entry of fuel into the tank, and one receiving valve for connection to the vent bottle/return vent.

Any other design of dry break coupling, which operates on an alternative principle to that of Diagram 1, must be specifically approved by CAMS and the subsequent permission, if granted, will be noted in the log book of the subject vehicle.

Maintenance: Competitors are advised it is extremely important to maintain all refuelling equipment in good working order. O-rings must be regularly inspected and replaced if there are any signs of expansion or damage. Springs and tracks must also be regularly inspected and kept lubricated during those times the refuelling valves are not in operation.

5. **REFUELLING**

Refuelling may be undertaken by one of two methods viz churns or an overhead rig.

5.1 **Refuelling by Churns**

- (i) **General:** This procedure covers the refuelling of a car using churns.

- (ii) **Design Requirements:** The maximum capacity of each churn is 40 litres.

Each churn must be designed to prevent fuel spillage regardless of the angle at which the churn is oriented.

Each churn must be fitted with a male probe of the specified design (see Article 4).

The angle of the axis of the probe head in relation to the longitudinal centre line of the churn is free, however it may not be mechanically variable during refuelling operations.

There must be minimum flexibility between the probe and the churn.

See Diagram 2 for a general design of churns.

- (iii) **Use:** Only one churn at a time may be used to refuel a car.

Each churn must be totally removed from the receiving unit prior to the next churn being inserted into the receiving unit.

All churns and associated equipment must either remain behind the pit wall or be contained entirely within the pit garage. Churns may be moved into pit lane from the pit garage a maximum of three minutes prior to any pit stop.

5.2. **Refuelling by Overhead Rig**

- (i) **General:** This system envisages fuel being stored in a single tank, at a specific maximum height above the pit lane. Vehicles will be refuelled via a single flexible hose which in turn is fitted with a male probe unit of standard design (see Article 4). The rig must be fitted with a fast action cut off valve which operates on the "dead man" principle. This valve must be attached directly to the fuel reservoir. See Diagram 3.

- (ii) **Design Requirements:** The maximum height

Diagram 1: General Design of Dry Break Coupling

Standard coupling (probe and receiver unit)

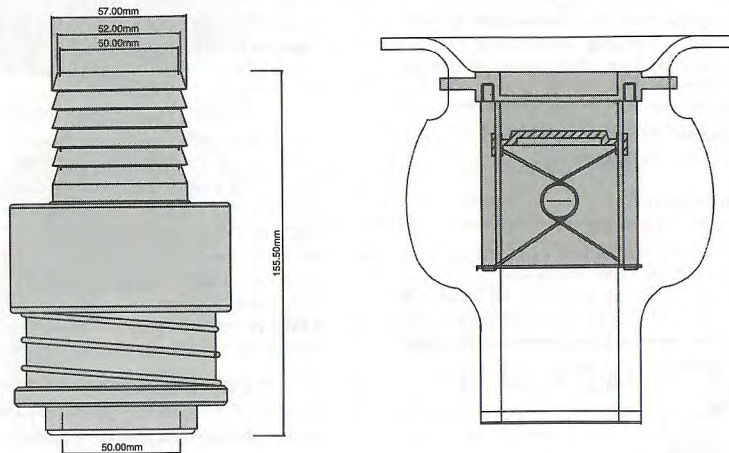

Diagram 2: General Design of Churn

Typical refuelling churn

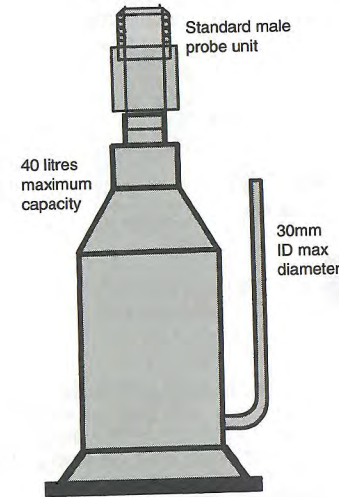
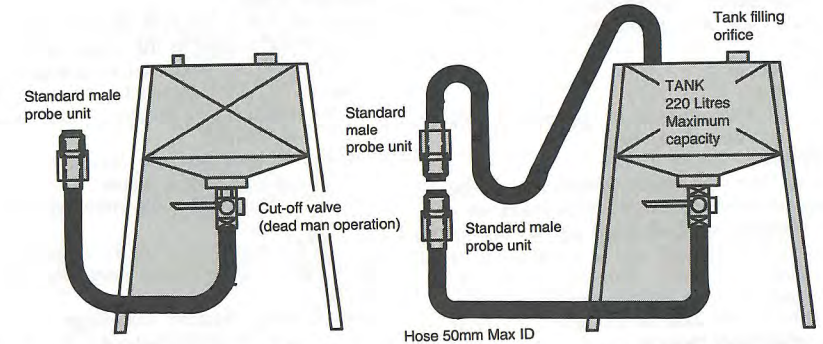

Diagram 3: General Design of Overhead Rig



3A: Overhead rig with single fuelling hose

3B: Overhead rig with return vent and refuelling hose

of any part of the rig which contains fuel is two metres above the pit lane. Only non-fuel holding connections and vents are permitted above two metres.

The maximum capacity of the reservoir is 220 litres.

A fast action cut-off valve, operating on the "dead man" principle, must be fitted directly to the reservoir.

A single delivery hose, which must be of a flexible rubber or a fuel resistant reinforced plastic material must be connected to the "dead man" valve.

The flexible part of the hose must be at least 2.5m in length.

The flexible hose must be connected to

the male probe. An solid connecting sleeve (maximum length 300mm) is permitted between the hose and the probe, to assist with ease of handling.

The head of the male probe and all other metal parts of the system must be electrically connected to ground via a lead clipped to the delivery hose.

All parts of the refuelling system, including the male probe, the flexible hose, any connection sleeve, the cut-off valve and the reservoir must be electrically continuous and efficiently grounded.

The reservoir must be vented via an explosion safe and long burning vent.

A filling orifice (maximum dimension 50mm) may be fitted to the main reservoir. Any refilling operations to the main reservoir must be carried out bearing in mind civil Occupational Health and Safety regulations.

No artificial pressurisation of the reservoir is permitted.

The vent must be open to the atmosphere and only atmospheric pressure may be exerted

on the fuel in the main reservoir.

Any device which changes the ambient temperature of the fuel is prohibited.

The rig shall not be moved once filled and must be completely drained before moving.

The fire attendant must be "ready for action" during any refilling operations.

- (ii) **Use:** The rig, including the reservoir and delivery hose, must either remain behind the pit wall or be contained entirely within the pit garage. The delivery hose may only be moved into pit lane from the pit garage a maximum of three minutes prior to any pit stop. While in pit lane, the delivery hose must at all times be held by the relevant attendant.

Schedule N – Fuel Tanks and Refuelling: Part 2 (continued)

Diagram 4: General Design of Vent Bottles

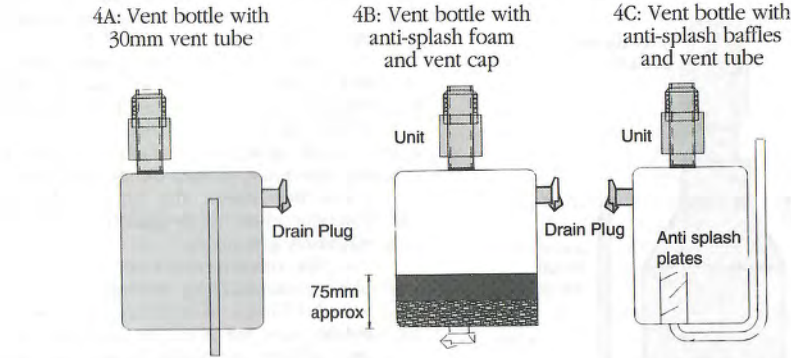

20 Litre maximum capacity

Vent tube max 30mm ID

6. VENTING DURING REFUELLING OPERATIONS

In all refuelling operations, the fuel tank(s) of the vehicle must be vented through a standard coupling (see Article 4), by one of two methods:

- a vent bottle; or
- a return vent.

The return vent method is permitted only when using an overhead rig.

6.1 Vent Bottles

- (i) **General:** The vent bottle system allows the fuel tank to be vented to the atmosphere via a standard coupling of identical size to that of the fuel receiving unit and a transparent or translucent container. This allows the refuelling attendant to visually determine when the tank is full and is designed to vent displaced air from the tank.
- (ii) **Design Requirements:** The maximum capacity of the vent bottle is 20 litres.

It must be constructed of an unbreakable, fuel resistant material, to a design which allows the contents of the bottle to be clearly seen.

The vent bottle must be fitted with a male probe standard coupling (see Article 4).

The vent bottle must be fitted with a device which allows any contents in the bottle to be drained. This device must be closed during refuelling.

The bottle may be vented by one of three methods (see Diagram 5). It must not be possible for liquid to escape from the vent bottle during a refuelling operation.

The maximum internal diameter of the vent to the atmosphere which is used during refuelling is 30mm.

- (iii) **Use:** During refuelling operations, the vent

bottle must be inserted prior to the insertion of the delivery hose and may be removed only after the removal of the delivery hose or churn.

The vent bottle must be empty of liquid before each use.

The vent bottle must never be used as a refuelling container.

6.2 Return Vents

- (i) **General:** The return vent allows a fuel tank of a car to be vented to the ullage space in the reservoir of the overhead refuelling rig (see Diagram 5). Care should be exercised due to the additional piping required when using this method of venting.

- (ii) **Design Requirements:** Maximum internal diameter at vent hose is 50mm.

The vent hose must only return to the reservoir tank.

If this system is used, the reservoir of the main tank must be vented externally to any pit garage.

- (iii) **Use:** If using "siamese" couplings, the equipment must be manufactured in a manner which allows the vent coupling to engage prior to the refuelling coupling and likewise the vent coupling must disengage after the refuelling coupling.

Diagram 5: General Design of Siamese Coupling

Siamese Coupling



Standard male probe unit

Section 8

5th Category – Historic Cars

Table of Contents

| | |
|--|--------------------|
| General Regulations | 8 - 2 |
| Regularity Trials | 8 - 4 |
| Group J - Vintage Cars | (Pre-1931) 8 - 5 |
| Group K - Post-Vintage Thoroughbred Cars | (1931-1940) 8 - 6 |
| Group L - Historic Racing & Sports Cars | (1941-1960) 8 - 8 |
| Group M - Historic Racing & Sports Racing Cars | (1961-1965) 8 - 10 |
| Group Na - Production Touring Cars | (Pre-1958) 8 - 12 |
| Group Nb - Touring Cars | (1958-1965) 8 - 14 |
| Group Nc - Touring Cars | (1965-1972) 8 - 16 |
| Group O - Historic Racing & Sports Racing Cars | (1966-1969) 8 - 18 |
| Group P - Formula 5000 Racing Cars | (Pre-1978) 8 - 20 |
| Group Q - Historic Racing & Sports Cars | (1970-1977) 8 - 21 |
| Group Sa - Production Sports Cars | (1941-1960) 8 - 23 |
| Group Sb - Production Sports Cars | (1961-1969) 8 - 24 |
| Group Sc - Production Sports Cars | (1970-1977) 8 - 26 |
| Seats - Groups Na, Sa, Sb & Sc | 8 - 28 |
| Tyre List - Groups J, K & L | 8 - 29 |
| Tyre List - Groups Na, Nb, Nc, Sa, Sb & Sc | 8 - 30 |

5th Category – Historic Cars: General Regulations

1. PREAMBLE

1.1 The following definitions and general requirements governing Historic Cars have been adopted to facilitate the organisation of competitions and meetings in which such vehicles are involved.

1.2 Events for vehicles within the 5th Category may be programmed to cater for:

- (i) group racing: specific individual groups within the category; or
- (ii) combined group racing: a combination of several specific individual groups; or
- (iii) divisional racing: a combination of vehicles from any of the individual groups with eligible vehicles selected on the basis of their perceived compatibility in performance potential. Any number of events of this type may be programmed at any one meeting to divide the overall entry into compatible performance divisions.

Engine capacity classes may be incorporated in any of these types of events or an overall engine capacity limitation placed on any event. It would generally be preferred that any engine capacity limitations selected be consistent with those commonly in use during the relevant period.

No specific limitations are imposed on vehicle combinations which will be permitted in combined group or divisional events but fields should consist of vehicles which are generally compatible in performance potential.

CAMS will hold the absolute discretion to disallow any proposed vehicle combinations which it considers might create safety hazards arising from speed differentials or visibility problems. It would for example not generally be appropriate to combine events for Groups P and Q with those for earlier vehicles because of the speed differential involved or to combine events for Group Na, Nb or Nc with other groups because of speed differentials.

Within any group or combined group event, it will be permissible to include by invitation individual vehicles from other groups where such action is considered desirable to achieve the most performance-compatible field. Where such action is taken notation should be made in the program to record the subject vehicles' correct group classification and the event should be described in the program as including vehicles from other groups by invitation.

When programming combined group or divisional racing events, consultation with the state member of the Historic Commission or Historic Eligibility Committee is encouraged to assist determination of the most compatible mix of vehicles.

1.3 The express purpose of these regulations is to ensure that vehicles in the various groups compete in a condition, mechanically and visually,

compatible with the period of racing being portrayed. "Updating" in whatever form is not condoned. CAMS reserves the right to reject any vehicle which it considers not within the spirit of these regulations. Vehicles must conform with the appropriate group date specification in concept and in detail. Where any doubt exists between Historic regulations and the original period specification, the latter will take precedence.

1.4 CAMS in its absolute discretion reserves the right to accept or reject any vehicle for Historic classification. The issue of all log books must be firstly authorised by the Historic Eligibility Committee through CAMS National Office. A central register of Historic vehicles in all groups is maintained, and the issue of all Historic log books is carried out through CAMS National Office.

All new Historic Vehicle Log Books being issued are accompanied by an Historic Certificate of Description which is a Recognition Certificate for the vehicle concerned.

A Temporary Permit to Compete may be issued at the sole discretion of CAMS, in circumstances where a vehicle is visiting temporarily from outside of Australia, and otherwise at the sole discretion of CAMS.

(Competitors should be aware of the requirements of Schedule L – Vehicle Log Books.)

1.5 CAMS reserves the right to classify, withdraw classification, or re-classify a vehicle to a group which in its absolute discretion CAMS believes it conceptually belongs.

1.6 Before commencing construction of a special or the acquisition and/or restoration of a vehicle, it is most advisable that CAMS National Office or the State Historic Eligibility Officer be contacted regarding eligibility of the said vehicle.

1.7 CAMS may approve re-creation of significant vehicles which have been destroyed under the following conditions:

- there may be only one re-creation;
- CAMS must **approve in principle** vehicles prior to the commencement of the project. It should be noted that this does not in itself guarantee the acceptance of the vehicle which shall always be the subject of inspection and approval by CAMS when completed;
- there must be justification for the project, ie, it must be a significant vehicle, and only a faithful re-creation will be considered.

1.8 Three-wheeled vehicles participating in events exclusively for Historic vehicles are exempted from NCR 12.

1.9 The original style of paintwork and livery is encouraged.

The name of the driver may be shown on the vehicle, appearing once on either side in a

5th Category – Historic Cars: General Regulations (continued)

position below the window line, in a size not larger than 40mm by 300mm.

A club badge, of an acceptable motoring club, can appear on the vehicle. Each badge must be not larger than 150mm by 100mm and must be placed below the window line. Only two such badges are permitted.

The territory of origin of the driver may be shown on the vehicle. Each sign must be not larger than 100mm by 150mm and must be placed below the window line. Only two such signs are permitted, one on each side of the vehicle.

No other advertising material or sign is permitted unless evident in the applicable group period. (See relevant Group Articles.)

1.10 Additional information and advice is provided in the *Guide to Historic Racing* which is available from CAMS National or State Offices.

2. GENERAL

2.1 Log Books:

The production of a properly entered Historic vehicle log book issued by CAMS is required by NCR 150.

Vehicles in all Historic groups are to comply with the requirement of Schedule L – Vehicle Log Books. In addition:

- (i) Vehicle Log Books must be endorsed for the 5th Category and/or titled "Historic Vehicle Log Book", and
- (ii) Vehicles must comply with their Certificate of Description (where such a document has been issued), such Certificate of Description being a Recognition Certificate referred to in Schedule L.

2.2 A Temporary Permit to Compete:

A Temporary Permit to Compete, specific to the 5th Category – Historic Cars, issued by CAMS is acceptable as an alternative to the possession of an Historic Vehicle Log Book as defined in 2.1 above.

2.3 Safety:

Vehicles in all Historic groups - while competing in events specifically limited to such vehicles - are exempted from CAMS requirements in respect of fire extinguishing systems (but not fire extinguishers) (refer Schedule H), scatter shields, roll bars (except Groups Na, Nb and Nc), safety-harness, minimum bodywork, towing eyes, firewalls (although the fitment of these devices is in some cases desirable), starter motors, reverse gears and safety fuel tanks.

These exemptions will not be applicable to any vehicle which was originally equipped with any of the above mentioned equipment or design features.

Vehicles using alcohol fuels must carry a CAMS-approved fire extinguisher, applicable for use on an alcohol fire.

All tanks equipped with a quick-release filler cap shall have a secondary locking device or be wired shut.

CAMS recommends that competitors wear an approved full-face helmet when driving in open vehicles (refer Schedule D).

Concerning roll bars, Historic vehicles (except Groups Na, Nb and Nc), are subject to the following possibilities:

- no roll bar (unless the vehicle was originally equipped with one); or
- a roll bar to the group period specifications; or
- a roll bar complying with Schedule J; or
- a roll bar specifically approved by CAMS.

2.4 Fuel:

The specific requirements for each group will be found in the relevant Regulations. It is mandatory that vehicles using alcohol fuels (where permitted) also carry a symbol in the form of the letter "A" in white on a red circle of approximately 115mm diameter with a white border. This symbol must be placed adjacent to the racing number on each side of the vehicle, and at the fuel filler cap.

2.5 Terminology:

The term "style", where used in relation to wheels, refers to Sankey, wire, cast steel centre etc.

By "original" is meant a component which is in all respects identically similar to that originally fitted, as produced by the manufacturer who produced the original component/s, and is indistinguishable from it in all respects.

By "period" is meant the applicable group period of the vehicle in question.

2.6 Supercharging:

Vehicles in this category fitted with superchargers are not subject to the 1.7 factor as to displacement.

2.7 Competition Numbers:

Groups J, K, Lb & Lc are exempted from the requirements as to background specified in Schedule K. Applications for exemption may be made in individual cases for other vehicles where the specified vehicle competed in such visual form during the group period.

2.8 Motorcycle Tyres:

Refer Groups J, K and L – List of Permitted Motorcycle Tyres on page 8-29.

HISTORIC

HISTORIC

1. PREAMBLE

Regularity Trials are a variation of the rules for Historic competition to allow those who are unwilling to race to run their vehicles for the enjoyment of themselves and the spectators. It is a competition being a trial of regularity; it is not a speed event. As such, it is exempted from some of the requirements of race competition.

The continuing existence of regularity trials relies upon the exercise of common-sense, and, more particularly, good judgement on the part of the organisers in accepting or rejecting entries for specific events. Gross variations in potential speed are not condoned, and lap times close to racing lap times for specific vehicles are also unacceptable.

2. DETERMINATION

The winner of the competition shall be the competitor who records a total event time closest to the time he nominated prior to the commencement of the competition.

3. SPECIAL CONDITIONS

Event promoters must pay special attention to the differential in lap times related to the slowest vehicle when selecting fields for Regularity Trials.

4. ELIGIBLE CARS

Historic vehicles complying with Group J, Group K, Group L and Group S Regulations are eligible; as are Sports and Grand Touring Vehicles both open and closed, manufactured before the end of December, 1970. Additionally, the inclusion of other vehicles is permitted subject to the Event Organiser hav-

ing reached agreement with the CAMS State Manager and the local Historic Commission or Historic Eligibility Committee officer.

5. EVENT STARTING

Vehicles will be assembled on the starting grid in the usual manner. Each row of vehicles will be started individually at a time interval of not less than two seconds between rows.

6. COMPETITOR REQUIREMENTS

CAMS Entrant and Driver licences are not required but competitors will be required to produce a CAMS Basic Licence and a current membership card of a car club affiliated with CAMS. Effective 1 January, 1996, no passengers may be carried.

7. SAFETY EQUIPMENT

Drivers must wear helmets and goggles as approved by CAMS. CAMS recommends that competitors wear an approved full-face helmet when driving in open vehicles (refer Schedule D).

Fire resistant clothing is not mandatory, but drivers must wear woollen or cotton clothing covering the body from ankles to wrists and neck, and suitable and appropriate footwear.

8. GENERAL

Vehicles competing in Regularity Trials shall comply with the general requirements of Schedule A and paragraph 1.3 of 5th Category Historic Car Regulations. Approved fire extinguishers are required. Vehicle log books are not required, but if a log book exists, it must be presented at scrutineering.

1. ELIGIBILITY

The classification of vehicles within the group will be at the absolute discretion of CAMS.

The group is intended to depict early racing car design and development to include the important period of significant excellence in design and workmanship defined as the "vintage" period. Vehicles eligible will be racing and sports cars with a competition history established prior to 31 December, 1930.

Consideration may also be given to the classification within this group of:

- one-off "special" type vehicles constructed at any time using major components (ie, engine, transmission, chassis, axles and suspension) manufactured prior to 31 December, 1930. Such vehicles may or may not have established a competition history but must be similar in detailed specification and appearance to vehicles which actually appeared in competition prior to 31 December, 1930;
- sports cars without an established competition history manufactured prior to 31 December, 1930. Such vehicles will generally be limited to those of a type which actually appeared in competition prior to 31 December, 1930.

Only vehicles in this group shall be eligible for any prize or trophy to be awarded to a Vintage car.

2. SPECIFIC REQUIREMENTS

2.1 Bodywork: Bodywork must be manufactured from materials and utilise construction methods evident in the period. Glass fibre and other similar materials are not permitted.

2.2 Cockpit: The cockpit configuration and materials must be compatible with the group period, particularly instruments, steering wheel and seats. The use of electronic instruments is not permitted.

2.3 Engine: Internal components of the engine are free, but cylinder block, crankcase and cylinder head/s must be original.

Cylinder head/s, crankcase and cylinder block must be as used together in the period. Interchange between makes or models is not permitted unless it can be demonstrated as common practice within the group period.

Dry sump lubrication is not permitted unless fitted as original equipment by the manufacturer.

Toothed belt drives are not permitted.

Any increase in swept volume shall be in keeping with the practice of the period on that particular type of vehicle and engine. The crankshaft stroke must be to the original specifications.

The exhaust system is free, but must be of a style evident in the group period.

2.4 Induction: The induction system must be of a type compatible with the vehicle within the group period. Post-1930 carburettors are not

permitted except in the case of SU instruments, in which case later units up to and including "H" type are accepted.

Multi-choke carburettors and/or superchargers are not permitted unless they were used on that type of engine in the period, and they are of a period type. Fuel injection and/or turbo charging is not permitted.

2.5 Transmission: Gearbox casings must be original and contain the original number of forward ratios. Internal components are otherwise free. Austin 7 Specials may use a "Works Type" four-speed conversion within a Group J period three-speed case.

All external components of the final drive assembly must be of the period, with the exception of the "nose piece" which is free. All internal components are free.

2.6 Brakes: The braking system must be of a type fitted to the vehicle within the period save that:

- mechanical actuation may be converted to hydraulic operation; and
- dual/tandem master cylinders may be fitted. Disc brakes and/or non period brake boosters are not permitted.

2.7 Suspension: The suspension system must remain unchanged from a specification evident during the group period and applicable to the subject vehicle.

Fore and aft axle location may be varied, but transverse location may not.

Hydraulic shock absorbers are not permitted unless fitted as original equipment or used on the subject vehicle within the group period.

Spherical or "Rose" type joints are not permitted.

2.8 Wheels and Tyres: Wheels of the original style, diameter and rim width must be used.

In the case of new specials, the minimum rim diameter is 18" and the maximum rim width is 3 1/2".

Tyres must have a minimum aspect ratio of 70 percent as determined by the Tyre and Rim Association and, within the limitations of availability and practicality, must be consistent in general appearance and tread pattern with those fitted to the vehicle or similar vehicles during the group period.

In addition, the use of a motorcycle tyres is permitted for use in this group, provided they are fitted on the correct width rims and are operated within their specified load rating. The permitted list of motorcycle tyres appears on page 8-29.

2.9 Fuel: Commercial fuel as defined by CAMS must normally be used (refer Schedule G). However, provided it can be demonstrated that the subject vehicle used other than commercial fuel during the group period, alternative fuels may be permitted subject to prior approval of the Historic Eligibility Committee. Such approval must be verified in the vehicle log book.

- 2.10 **Electrical equipment:** Alternators, electric fans, and any form of electronic ignition devices are not permitted. Electric starter motors may be fitted. Sports cars must be fitted with operable lighting and generating equipment compatible with the period.

Group K – Post-Vintage Thoroughbred Cars (1931-1940)

1. ELIGIBILITY

The classification of vehicles within this group will be at the absolute discretion of CAMS.

The group is intended to cater for vehicles from the pre-World War 2 period and the early post-World War 2 period including classically engineered factory constructed vehicles, local specials constructed on a "one-off" basis using production car components from the pre-war period and some factory constructed vehicles which were modified during the group period, and fitted with engines from pre-war production vehicles.

Vehicles eligible will be racing and sports cars with a competition history established in the period between 1 January, 1931 and 31 December, 1949, but constructed using major components (ie, engine, transmission, chassis, axles and suspension) manufactured prior to 31 December, 1945. Consideration may also be given to the classification within this Group of:

- One-off "special" type vehicles constructed at any time using major components (ie, using engine, transmission, chassis, axles and suspension) manufactured prior to 31 December, 1945. Such vehicles may or may not have an established competition history but must be similar in detailed specification and appearance to vehicles which actually competed in competition between 1 January, 1931 and 31 December, 1940.
- Sports cars without an established competition history manufactured between 1 January, 1931 and 31 December, 1940. Such vehicles will generally be limited to those of a type which actually appeared in competition prior to 31 December, 1949.

Vehicles in this group only shall be eligible for any prize or trophy to be awarded to a PVT car.

2. SPECIFIC REQUIREMENTS

- 2.1 **Bodywork:** Bodywork must be manufactured from materials and utilise construction methods evident in the period. Glass fibre and other similar materials are not permitted.
- 2.2 **Cockpit:** The cockpit configuration and materials must be compatible with the group period, particularly instruments, steering wheel and seats. The use of electronic instruments is

- not permitted.
- 2.3 **Engine:** Internal components of the engine are free, but cylinder block, crankcase and cylinder head/s must be original.

Cylinder head/s, crankcase and cylinder block must be as used together in the period. Interchange between makes or models is not permitted unless it can be demonstrated as common practice within the group period.

Dry sump lubrication is not permitted unless fitted as original equipment by the manufacturer.

Toothed belt drives are not permitted.

Any increase in swept volume shall be in keeping with the practice of the period on that particular type of vehicle and engine. The crankshaft stroke must be original.

The exhaust system is free but must be of a style evident in the group period.

The induction system must be of a type compatible with the vehicle within the group period.

Post-1940 carburettors are not permitted except in the case of SU instruments, in which case later units up to and including "H" type are acceptable.

Multi-choke carburettors and/or superchargers are not permitted unless they were used on that type of engine in the period and they are of a period type.

Fuel injection and/or turbocharging is not permitted.

2.4 Transmission:

Gearbox casings must be original and contain the original number of forward ratios. Internal components are otherwise free.

All external components of the final drive assembly must be of the period, with the exception of the "nose piece" which is free. All internal components are free.

- 2.5 **Brakes:** The braking system must be of a type fitted to the vehicle within the group period save that:

- (i) mechanical actuation may be converted to hydraulic operation;
- (ii) dual/tandem master cylinders may be fitted.

- 2.6 **Suspension:** The suspension system must remain unchanged from a specification evident during the group period and applicable to the subject vehicle.

Fore and aft axle location may be varied, but transverse location may not.

Hydraulic shock absorbers are not permitted unless fitted as original equipment or used on the subject vehicle within the group period.

Spherical or "Rose" type joints are not permitted.

- 2.7 **Wheels & Tyres:** Wheels of the original style, diameter and rim width must be used.

In the case of new specials, the minimum rim diameter is 16" and the maximum rim width is 4".

Tyres must have a minimum aspect ratio of 70 percent as determined by the Tyre and Rim Association and, within the limitations of availability and practicality must be consistent in general appearance and tread pattern with those fitted to the vehicle or similar vehicles during the group period.

In addition, a selected list of motor cycle tyres is permitted for use in this group provided

ed they are fitted on the correct width rims and are operated within their specified load rating. Short life and low profile tyres will not be permitted.

The permitted list of motorcycle tyres appears on page 8-29.

- 2.8 **Fuel:** Commercial fuel as defined by CAMS must be used (refer Schedule G). However, provided it can be demonstrated that the subject vehicle used other than commercial fuel during the group period, alternative fuels may be permitted subject to the prior approval of the Historic Eligibility Committee. Such approval must be verified by appropriate endorsement in the vehicle log book.

- 2.9 **Electrical Equipment:** Alternators, electric fans, and any form of electronic ignition devices are not permitted. Electric starter motors may be fitted. Sports cars must be fitted with operable lighting and generating equipment compatible with the period.

Group L – Historic Racing & Sports Cars (1941-1960)

1. PREAMBLE

The classifications of Groups Lb and Lc refer to the eligibility of vehicles and not necessarily to the composition of race fields. It would be expected to be normal practice for Lb and Lc cars to race together in events titled Group L.

Group Lb

1. ELIGIBILITY

The classification of vehicles within this group will be at the absolute discretion of CAMS.

Vehicles classified in this group will reflect the post-World War 2 period of technology changes extending from the first of the post-war designs through an evolution culminating with the first of the mid-engined vehicles of the late 1950s.

Eligibility will be open to racing and sports cars with a competition history established in the period between 1 January, 1941 and 31 December, 1960, but excluding vehicles constructed from pre-1940 components which are eligible for classification in Group K. The group will include all vehicles constructed specifically to the post-war 500cc Formula 3 even if such vehicles are constructed from pre-1946 components.

Consideration may also be given to the classification within this group of vehicles constructed between 1 January, 1941 and 31 December, 1960 but with a competition history established subsequent to 31 December, 1960 or, in some circumstances, without a racing history provided the specification of the vehicle is consistent with the general standard of technology evident in vehicles raced during the group period and the vehicle is compatible in appearance with such vehicles.

2. SPECIFIC REQUIREMENTS

- 2.1 **Bodywork:** Bodywork must be unmodified from that fitted to the particular vehicle within the group period.

Vehicles are to run with all bodywork intact unless it was customary for the particular vehicle to do otherwise within the group period (eg, some mid-engined vehicles customarily ran without an engine cover).

- 2.2 **Cockpit:** The cockpit configuration, particularly seat/s, steering wheel and instruments must be as fitted to the particular vehicle within the group period. Electronic instruments are not permitted.

- 2.3 **Engine:** The internal components of the engine are free save that the original cylinder block and cylinder head/s must be used. Crankshaft stroke must remain unaltered from the period specification on the subject vehicle.

The bore may be increased to a maximum of 1.5mm beyond the dimension evident

on the subject vehicle within the group period.

Toothed belt drives and dry sump lubrication systems may be used only if fitted to the subject vehicle within the group period.

The exhaust system is free, but must be of a style evident in the group period. Any vehicle which was fitted with a distinctive or characteristic exhaust system in the group period is encouraged to retain it.

The inlet manifold is free, but carburettors must be of the make, model and number fitted to the vehicle in the group period. The choke size may be altered. Superchargers, fuel injection and multi-choke carburettors are permitted only if fitted to the subject vehicle within the group period, and must be to unaltered specification.

Motor cycle engined vehicles originally fitted with Amal carburettors may use Amal Concentric Mk 1 carburettors.

- 2.4 **Transmission:** Gearbox casings, transaxles, the number of forward ratios and gear change mechanisms must be unaltered from period specifications on the subject vehicle. Components are otherwise free.

External components of the final drive assembly must be unaltered from period specifications. Internal components are free.

- 2.5 **Brakes:** The braking system must be of the same type fitted to the vehicle within the group period. Drum brake systems may not be replaced by disc brake systems.

Brake discs and callipers must be of the make, style and size fitted within the group period.

Drum brakes may be replaced by others of period type. Cooling fins, scoops and ventilating holes may be added.

Dual/tandem master cylinders may be fitted.

Mechanical actuation may be converted to hydraulic operation.

- 2.6 **Suspension:** The suspension must be unaltered from the period specification on the subject vehicle, save that:

- spring rates, ride height and damper settings are free. Fore and aft axle location on beam axle vehicles may be varied;
- transverse location may not be altered from period specifications on the subject vehicle; and
- externally adjustable shock absorbers and spherical or "Rose" type joints are permitted only if fitted to the subject vehicle in the group period.

- 2.7 **Wheels & Tyres:** Wheels must be unaltered from period specification on the subject vehicle in diameter and style. Rim width may not exceed 5" unless rims in excess of this dimension were fitted to the subject vehicle within the group period.

Tyres must have a minimum aspect ratio

Group L – Historic Racing & Sports Cars (1941-1960) (continued)

of 70 percent as determined by the Tyre and Rim Association and within the limitations of availability and practicality must be consistent in general appearance and tread pattern with those fitted to the vehicle or similar vehicles during the group period; in which case the rim width must be as originally used.

In addition, a selected list of motor cycle tyres is permitted for use in this group, provided they are fitted on the correct width rims and are operated within their specified load rating.

The permitted list of motorcycle tyres appears on page 8-29.

Short life and low profile tyres will not be permitted. Historic period design tyres made with modern "sticky" compounds are not acceptable. Tread patterns must be of period historic style.

- 2.8 **Fuel:** Commercial fuel as defined by CAMS must be used (refer Schedule G). However, provided it can be demonstrated that the subject vehicle used other than commercial fuel during the group period, alternative fuels may be permitted subject to the prior approval of the Historic Eligibility Committee. Such approval must be verified by appropriate endorsement in the vehicle log book.

- 2.9 **Electrical Equipment:** All electrical equipment must be unaltered from period specifications on the subject vehicle and remain fully operative. Alternators, electric fans and any form of electronic ignition devices are not permitted. Electric starter motors may be fitted.

Group Lc

1. ELIGIBILITY

Production sports cars recognised by CAMS, manufactured after 1 January, 1941, but prior to 31 December, 1960.

Vehicles which are of such construction as to readily permit the removal of mudguards and windscreen - where these do not form an integral part of the body - may qualify for Group Lc. Where it can be demonstrated that a vehicle of the subject type competed in this form in the group period, these vehicles may compete in stripped form as racing cars or, with said equipment fitted, they may also compete as sports cars.

Vehicles may vary from original specifications in a manner which is consistent with retaining the nature of a road registered and road used vehicle. In particular, no change to track, wheelbase, engine position or suspension medium may be made.

Engine and transmission must be of the type normally fitted to the model in question.

Vehicles in this group are not required to have a racing history.

2. SPECIFIC REQUIREMENTS

- 2.1 **Bodywork:** All elements of the bodywork - including external fuel tank if original equipment on the subject vehicle - must be original, save that cycle type mudguards may be used.

Cycle-type mudguards, if fitted, must provide coverage of at least one third of the circumference of the tyres, over at least the full width of the wheel and tyre, as it is viewed both vertically and horizontally. A steel bonnet may be replaced by a bonnet of alloy construction. Louvres may be added to or omitted from the bonnet. In the case of vehicles with multiple piece folding bonnets, the sides may be removed. Original body bulkheads and fire walls must be intact and all doors must be operable.

When competing as a racing car the removal of mudguards, lamps, spare wheel, running boards and mounting brackets is permitted.

- 2.2 **Cockpit:** The configuration and materials of the cockpit, in particular the steering wheel, instruments and seats, must be compatible with the group period. Electronic instruments are not permitted.

The cockpit must be of a stripped rather than a specially-constructed nature.

The passenger seat may be removed when the vehicle is competing as a racing car.

- 2.3 **Engine:** The internal components of the engine are free save that the original cylinder block and cylinder head/s must be used. The crankshaft stroke must remain unaltered from the period specification on the subject vehicle.

The cylinder head/s may be modified provided such modification is effected only by the removal of metal.

The cylinder bore may be increased by a maximum of 1.5mm beyond original manufacturer's dimensions.

Toothed belt drives are not permitted.

Dry sump lubrication system is not permitted unless original equipment.

The exhaust system is free but should be of a type compatible with the period.

Inlet manifolds are free but carburettors must be of the original make, model and number on the vehicle. The choke size is free. Superchargers, multi-choke carburettors or fuel injection are permitted only if part of the original specification for that make and model, and must remain unchanged from that original specification.

- 2.4 **Transmission:** Gearbox casings, gearbox selection mechanisms and the number of forward ratios must be to the original manufacturer's design specifications. Internal components are otherwise free.

The external components of the final drive assembly must be unaltered from period specifications. Internal components are free.

Group L – Historic Racing & Sports Cars (1941-1960) (continued)

- 2.5 **Brakes:** In the case of disc brake systems, the brake disc and callipers must be original. Drum brakes may be modified or replaced with others of a period type. Drums and/or backing plates may be ventilated and/or fitted with cooling fins.
Dual/tandem master cylinders may be fitted.
Mechanical actuation may be converted to hydraulic operation.
Drum brakes may not be replaced by disc brakes.
- 2.6 **Suspension:** The suspension must be unaltered from the original specifications save that spring rates, ride height and damper settings may be altered.
Adjustable shock absorbers are not permitted.
Fore and aft axle location may be varied but transverse location may not be altered.
Spherical or "Rose" type joints are not permitted.
- 2.7 **Wheels & Tyres:** Must be unaltered from period specification on the subject vehicle in diameter and style.
Wheel sizes are to be as commonly used on vehicles of this type in the period, eg, MG TC: 16" diameter by 4" rim width.
In no circumstances may wheel diameter be less than 15" nor rim width greater than 5".
Tyres must have a minimum aspect ratio of 70 percent as determined by the Tyre and Rim Association and within the limitations of availability and practicality must be consistent in general appearance and tread pattern with those fitted to the vehicle or similar vehicles during the group period.
In addition, a selected list of motor cycle tyres is permitted for use in this group, provided they are fitted on the correct width rims and are operated within their specified load rating.
Short life and low profile tyres will not be permitted. Historic period design tyres made with modern "sticky" compounds are not acceptable. Tread patterns must be of period historic style.
The permitted list of motorcycle tyres appears on page 8-29.
- 2.8 **Electrical Equipment:** All electrical equipment must be unaltered from the original specifications and be fully operative.
Dynamo/generator may not be replaced by an alternator.
Electric fans and any form of electronic ignition devices are not permitted.
The generator and/or lighting equipment may be removed whilst vehicles are participating as racing cars.
- 2.9 **Optional Equipment:** Optional equipment is permitted in this group only if detailed in either:
- an original manufacturer's workshop manual; or
 - a spare parts catalogue; and
 - is specifically accepted by CAMS.

Group M – Historic Racing & Sports Racing Cars (1961-1965)

1. ELIGIBILITY

The classification of vehicles within this group will be at the absolute discretion of CAMS.

The group is intended to cater for racing, sports racing and sports cars with a competition history established in the period between 1 January, 1961 and 31 December, 1965. Such vehicles will reflect the development of more advanced design features such as complex space frame and monocoque structures, sophisticated adjustable suspension systems and the commencement of wide racing tyre development.

Consideration may also be given to the classification within this group of vehicles constructed between 1 January, 1961 and 31 December, 1965 but with a competition history established subsequent to 31 December, 1965 or, in some circumstances, without a racing history, provided the specification of the vehicle is consistent with the general standard of technology evident in

vehicles raced during the group period, and the vehicle is compatible in appearance with such vehicles.

Formula Vee vehicles are specifically excluded from this Group.

2. SPECIFIC REQUIREMENTS

- 2.1 **Bodywork:** Bodywork must be unmodified from that fitted to the particular vehicle within the group period.

Vehicles should run with all bodywork intact unless it was customary for the particular vehicle to do otherwise (eg, some mid-engined vehicles customarily ran without the engine cover).

- 2.2 **Cockpit:** The cockpit configuration, including seat/s, steering wheel and instruments must be as fitted to the particular vehicle within the group period.

- 2.3 **Engine:** Internal components of the engine are free save that the original cylinder block and cylinder head/s must be used. The crankshaft stroke must remain unaltered from the period

Group M – Historic Racing & Sports Racing Cars (1961-1965) (cont'd)

specification on the subject vehicle.

The bore may be increased to a maximum of 1.5mm beyond the dimension evident on the subject vehicle in the group period.

Toothed belt drives and dry sump lubrication systems may be used only if fitted to the subject vehicle within the group period.

The exhaust system is free, but should be of a period type. Any vehicle which was fitted with a distinctive or characteristic exhaust system in the group period is encouraged to retain it.
Inlet manifolds are free.

- 2.4 **Induction:** Carburettors must be of the period make, model and number fitted to the vehicle in the group period and must be to unaltered specification. Turbo charging is not permitted.

- 2.5 **Transmission:** Gearbox casings, transaxles, the number of forward ratios and gear change mechanisms must be unaltered from period specifications on the subject vehicle. Internal components are otherwise free. Vehicles which were fitted with VW based transmissions in the group period may not use Holinger or Hewland quick change units or features unless so equipped originally.
External components of the final drive assembly must be unaltered from period specifications on the subject vehicle. Internal components are free.

- 2.6 **Brakes:** The braking system must be of the same type fitted to the subject vehicle within the group period.

Drum brakes may be replaced by others of period type.

Cooling fins, scoops and ventilating holes may be added.

Mechanical actuation may be converted to hydraulic operation.

Brake discs and callipers must be of the make, style and size fitted to the subject vehicle within the group period.

Drum brake systems may not be replaced by disc brake systems.

Dual/tandem master cylinders may be fitted.

- 2.7 **Suspension:** The suspension must be unaltered from the period specifications on the subject vehicle.

Spring rates, ride height and damper settings are free. Fore and aft axle location on beam axle vehicles may be varied. Transverse location may not be altered from group period specification.

Externally adjustable shock absorbers and "Rose" type joints are permitted only if fitted to the subject vehicle in the group period.

- 2.8 **Wheels and Tyres:** Wheels must be unaltered from period specifications of the subject vehicle in diameter, width and style. Cast alloy wheels may be replaced by wheels cast in a different material and provided the replacement remains identical as to dimensions and

appearance.

Tyres must have a minimum aspect ratio of 60 percent as determined by the Tyre and Rim Association and, within the limitations of availability and practicality, must be consistent in general appearance and tread pattern with those fitted to the vehicle or similar vehicles during the group period.

The use of motorcycle tyres or slick treaded tyres is prohibited.

- 2.9 **Fuel:** Commercial fuel as defined by CAMS must be used (refer Schedule G). However, provided it can be demonstrated that the subject vehicle used other than commercial fuel during the group period, alternative fuels may be permitted subject to the prior approval of the Historic Eligibility Committee.

Such approval must be verified by appropriate endorsement in the vehicle log book.

- 2.10 **Electrical Equipment:** electrical equipment must be unaltered from period specification on the subject vehicle and remain fully operative. Alternators, electric fans and any form of electronic ignition devices are not permitted.

An electric starter motor may be fitted.

Group Na – Production Touring Cars (Pre-1958)

Group Na is designed to provide a forum for competitors to race pre-war production touring cars and early post-war production touring cars in a form similar to club racing of the period. To this extent, the modifications permitted are those that are not intended to radically alter the individual vehicle's character or appearance and will be of an improved performance road car nature, as opposed to making the vehicle totally dedicated to outright competition; the concept being that the vehicles could be driven comfortably to and from the race meeting.

An important consideration in forming these Regulations was the need to provide eligibility rules which will require a minimum of administration, particularly at race meetings.

People wishing to race vehicles of a more highly-modified nature should look to other categories.

1. ELIGIBILITY

1.1 Production touring cars as recognised by CAMS, commercially available in Australia prior to 31 December, 1957, with the inclusion of certain run-on models. The vehicles must be of a touring form providing adequate normal seating for four or more adult persons. Vehicles classified in this group will not necessarily have a racing history. Factory-built competition variants of standard production vehicles or GT-type vehicles are not eligible for this Group.

1.2 **Classes:** Vehicles shall compete in the following capacity classes: Up to 1100cc
1101 - 1500cc
1501 - 3000cc
3001cc and over

Limited modifications may be made. These should be of a period nature and not out of character with the vehicle or group period.

1.3 **Eligible Vehicles:** A list of vehicles eligible for this group will be published by CAMS from time to time.

1.4 **Specifications:** Individual specifications will be produced for each type of vehicle, determining its specifications and allowable modifications.

2. BODY

2.1 **Bodywork:** The bodywork, body fittings and interior trim in its entirety must be supplied by the manufacturer save that wheel nave plates must be removed. Bumper bars must be retained.

2.2 **Cockpit:** The cockpit must be original save that floor coverings may be removed. The steering wheel may be replaced by another of the period style but the rear seat must be retained in all respects including location.

Vehicles must be fitted with original-type or CAMS-approved seats (refer to page 8-28). Some extra padding is allowed. Seats must be trimmed in the same, matching or complementary colours as other trim on the vehicle.

Original instruments must be intact. Additional instruments of a period type may be fitted. Electronic tachometers may be substituted for mechanically-driven units, provided they are compatible in face, style and size with the other instruments.

2.3 **Chassis:** Chassis or chassis-body unit must be original and unmodified.

3. PERMITTED MODIFICATIONS

Mechanical modifications may be made, provided that the following restrictions are observed:

3.1 **Engine:** Cylinder block and head must be original, or a CAMS-approved alternative.

Internal components of the engine are free save that the crankshaft stroke must be original.

The cylinder bore may be increased by a maximum of 1.5mm beyond original dimension.

Cylinder head/s may be modified provided such modification is effected only by the removal of metal.

Toothed belt drives are not permitted.

Dry sump lubrication is not permitted, unless originally fitted.

The exhaust system is free but should be of a type compatible with the period.

The cooling system must remain as standard, save that the radiator core is free as to thickness. Electric fans may be added.

3.2 **Induction:** Carburettors or fuel injection systems must be of the make and model originally available in the period. Bore size is free. Superchargers are not permitted unless part of the original specification. Multiple carburettors may be fitted in the ratio of one choke per two cylinders.

Inlet manifolds are free except that they must be of a type compatible with the period.

3.3 **Transmission:** Gearbox casing, gear selection mechanism and the number of forward ratios must be original. Internal components are otherwise free. External components of the final drive assembly must be unmodified from the original specification. Internal components are free. Limited slip or locked differential are not allowed unless part of original specification.

3.4 **Brakes:** The original form and type of braking system shall be employed. The major brake dimensions of drum brakes (ie, internal drum diameter and width) shall be as supplied as original equipment with a tolerance of 3mm permitted on drum diameter. Backing plates may be ventilated and/or fitted with cooling ducts.

Mechanical operation may be converted to hydraulic operation.

In the case of disc brake systems, the brake discs and callipers must be original.

Group Na – Production Touring Cars (Pre-1958) (continued)

Drum brakes may not be replaced by disc brakes. Dual or tandem master cylinders may be fitted. The installation of power brake assistance is permitted.

3.5 **Suspension:** The suspension must be unmodified from original specifications, save that spring rates, ride height and damper settings may be altered.

Suspension pickup points may not be modified. Eccentric or modified suspension components that alter the dimensions or geometry from original specifications are not permitted. Externally adjustable shock absorbers are not permitted.

Fore and aft axle location may be improved but transverse location may not be altered.

Fitment of period-type anti-sway bar to the front suspension is permitted.

Spherical or "Rose" type joints are not permitted.

3.6 **Wheels and Tyres:** Wheels are required to be original in diameter and style (ie, steel wheels may not be replaced by alloy wheels). Rim width may not exceed 5" unless originally specified by the manufacturer; in which case the rim width must be as originally supplied.

Tyres must have an aspect ratio of at least 65 percent as determined by the Tyre and Rim Association manual. (Refer Na, Nb, Nc, Sa, Sb and Sc Tyre List, page 8-30.)

3.7 **Electrical Equipment:** All electrical equipment must be unmodified from the original specifications and fully operative. The dynamo/generator may not be replaced by an alternator. Electronic ignition devices are not permitted.

4. SAFETY REQUIREMENTS

4.1 Vehicles shall comply with all relevant requirements of Schedules A, B and C.

4.2 A laminated windscreen is required in races and in multiple speed events. However, in the event that a laminated screen is unavailable,

approval may be given on individual application to CAMS for the fitment of a Lexan or Perspex windscreen.

4.3 CAMS-approved rollover protection and seat belts are compulsory. A roll bar or half cage conforming with Schedule J (Type 3 or Type 4) is required to be fitted to all vehicles. Roll cages are allowed. Side intrusion bars and other additional braces are permitted provided they do not pass through any part of the body-work.

Roll bar assemblies must not be installed so as to become a "de facto chassis" used to improve the torsional or beam strength of the original chassis. Head rests are strongly recommended but must be supported by the same structure that supports the driver's seat.

4.4 Foam-filled flexible fuel tanks are strongly recommended.

5. ADVERTISING

No advertising material or sign will be distributed from or carried on any vehicle in this category provided that this rule shall not apply to the manufacturer's usual name plate. CAMS reserves the right to permit also the display – in neat, unobtrusive lettering – of the name of the entrant and/or the driver and/or the State of his residence on the scuttle or the side of the vehicle. The total area of all such signs shall not exceed 75mm in height and 600mm in length on each side of the vehicle.

Club badges of an acceptable motoring club may appear on the vehicle. Each badge must be not larger than 150mm by 100mm and must be placed below the window line. Only two such badges are permitted.

The territory of origin of the driver may be shown on the vehicle. Each sign must be not larger than 100mm by 150mm and must be placed below the window line. Only two such signs are permitted.

No other signs may be displayed.

Group Nb – Touring Cars (Pre-1965)

Group Nb is the revised description of the group previously known as Appendix J, and more recently as Group N. It is a group for series production type touring cars, manufactured prior to 31 December, 1964. The group recognises models or components homologated for competition by the manufacturer, however at least 100 examples of a particular model must have been produced for the vehicle to be eligible.

Original vehicles with a competition history are welcome, however it is envisaged that most vehicles will not have a racing history and these are acceptable provided that they are accurate in detail, both mechanically and visually. In the case of original vehicles, they must conform with the mechanical specifications listed below, however minor modification undertaken and employed during the period are acceptable.

1. ELIGIBILITY

1.1 Series production type touring cars, manufactured prior to 31 December, 1964, of which 100 of the particular model must have been produced.

1.2 **Classes:** Vehicles shall compete in the following engine capacity classes:

| | | |
|----------|---|-----------------|
| Class G | - | Up to 1000cc. |
| Class F | - | 1001 to 1300cc. |
| Class E | - | 1301 to 1600cc. |
| Class D | - | 1601 to 2000cc. |
| Class C | - | 2001 to 2600cc. |
| Class B | - | 2601 to 3000cc. |
| Class A2 | - | 3001 to 4500cc. |
| Class A1 | - | Over 4500cc. |

(Classes may be amalgamated.)

2. BODY

2.1 The body must be of a touring hard-top form, and must provide adequate normal seating accommodation for four or more adults.

2.2 Vehicles in the above-mentioned Classes A, B, C, D, and E must have four doors unless they have been homologated by the FIA, or are otherwise specifically approved by CAMS, in a two-door version. Vehicles in Classes F and G must have at least two doors.

2.3 The bodywork, body fittings and interior trim in its entirety must be as supplied by the manufacturer except only that wheel nave plates must be removed, additional instruments fitted and the steering wheel replaced: provided that the replacement wheel is not less than 330mm in diameter (unless the original wheel was of a lesser diameter, in which case a replacement of at least equal diameter to the original is acceptable).

2.4 The use of undertrays, fairings etc, designed to improve the aerodynamic form of the automobile shall not be permissible unless supplied as standard equipment.

2.5 The original rear seats must be retained in all respects, including location.

The driver's seat may be replaced with a CAMS-approved driving seat.

The original passenger seat must remain in place – see Schedule C of Section 6. Such seats must be trimmed in the same, matching, or complementary colours as other trim on the vehicle.

On vehicles fitted with a bench front seat as original equipment, the whole seat may be removed, and the passenger seat must be a bucket seat from, eg, a comparable Falcon

Futura, Holden Premier etc. If the original equipment bench seat is retained, modification of the driver's portion of that seat is free so long as the origin of the seat may be determined.

2.6 Restoration of original trim is permitted, but should be as near as practicable to original specifications. Floor coverings may be removed. Insulating material may be added.

3. PERMITTED MODIFICATIONS

Mechanical modifications may be made, provided that the following restrictions are observed:

3.1 **Engine:** The original type of cylinder block and crankcase must be employed. The bore may be varied and/or the stroke reduced provided that the swept volume of the engine remains within the same cubic capacity class as that within which the engine came as supplied by the manufacturer (eg, EH Holden under 3000cc, Morris Cooper S under 1300cc).

The original type of cylinder-head casting must be employed. The cylinder-head may be modified provided that such modification is effected only by the removal of metal.

A dry sump is not permitted unless fitted as original equipment on the make and model of the vehicle of the period.

The radiator cooling fan may be removed; electrically powered fans are permitted.

3.2 **Induction:** Forced induction or fuel injection is not permitted, unless such induction method was employed as standard on the make and model of vehicle by the manufacturer concerned.

Later models of carburetors which were available in the period are acceptable, even with different throat sizes, provided that the outward appearance is the same.

Carburetors of a make not available in the period are unacceptable.

3.3 **Transmission:** The original type of gearbox and final drive assemblies including housings as supplied by the manufacturer for the make and model concerned shall be employed. The final drive assembly is otherwise free, save that the original housing must be retained (although it may be subject to any machining operations provided always that its origin is able to be established).

The number of gear ratios may not be changed.

3.4 **Suspension:** The original form and type of

Group Nb – Touring Cars (Pre-1965) (continued)

suspension only shall be employed (eg, a semi-elliptic leaf-spring suspended live rear-axle may not be replaced by a coil-spring suspended De Dion type, and so on).

At all times, the original form of steering and suspension joints must be employed, and in particular, may not be replaced by spherical or "Rose" type joints.

3.5 **Brakes:** The original form and type of brake system shall be employed (eg, drum brakes may not be replaced by disc brakes). The major brake dimensions (ie, internal drum diameter and width) shall be identical with the dimensions of these components as supplied as original equipment by the manufacturer concerned; provided that overall variation in the diameter of such drums of not more than 3mm shall be permissible. Modifications to disc brakes are limited to the freedom to fit alternative callipers of a type available pre-1965. Dual circuit braking systems are permitted, as is installation of power brake assistance. Brake lining material and hoses are free.

3.6 **Wheels and Tyres:** The wheels shall be either as supplied by the manufacturer or of a type approved by CAMS and which is in harmony with wheels used prior to 31 December, 1964. At all times the original wheel diameter shall be maintained, and the width of the rim may be increased by not more than 1" over the original, subject to an absolute maximum width of 6". Aluminium alloy type wheels may be fitted, but only of a design and style available prior to 31 December, 1964. Mudguard flares or extensions are not permitted unless they were fitted as original equipment by the manufacturer.

Tyres may not protrude outside the bodywork, but otherwise track is free.

Tyres must be of an approved type of radial or cross-ply construction with a minimum aspect ratio of 60 percent as determined by the Tyre and Rim Association. (Refer Na, Nb, Nc, Sa, Sb and Sc Tyre List, page 8-30.)

4. SAFETY REQUIREMENTS

4.1 A laminated windscreen is required in all vehicles. However, in the event that a laminated screen is unavailable, approval may be given on individual application to CAMS for the fitment of a Lexan or Perspex windscreen.

4.2 A roll bar or cage conforming with Schedule J (Type 4 or 5) is required to be fitted in all vehicles. Side intrusion bars and other additional braces are permitted provided they do not pass through any part of the bodywork. The roll bar or cage must not be used as a means of increasing the structural strength of the vehicle.

4.3 Foam filling of fuel tanks is permitted. The fuel tank may not be moved from its original location.

5. GENERAL

5.1 The vehicle shall be required to comply with such requirements of Schedules A, B and C as are applicable and not in conflict with this Group.

5.2 Electrical equipment in conformity with the requirements of Group 2A is required to be fitted.

5.3 A high standard of presentation will be insisted upon at all times. Any vehicle considered to be of inappropriate standard will be rejected.

5.4 At all times, the onus of proof of eligibility of the vehicle and/or components whether options or not, will be the responsibility of the owner, by way of homologation papers, parts manuals, workshop manuals etc.

In marginal cases, proof may be required to be produced to the effect that a vehicle of the same model was produced prior to 31 December, 1964.

6. ADVERTISING

No advertising material or sign will be distributed from or carried on any vehicle in this category provided that this rule shall not apply to the manufacturer's usual name plate. CAMS reserves the right to permit also the display – in neat, unobtrusive lettering – of the name of the entrant and/or the driver and/or the State of his residence on the scuttle or the side of the vehicle. The total area of all such signs shall not exceed 75mm in height and 600mm in length on each side of the vehicle.

Club badges of an acceptable motoring club may appear on the vehicle. Each badge must be not larger than 150mm by 100mm and must be placed below the window line. Only two such badges are permitted.

The territory of origin of the driver may be shown on the vehicle. Each sign must be not larger than 100mm by 150mm and must be placed below the window line. Only two such signs are permitted.

No other signs may be displayed.

7. SPIRIT OF REGULATIONS

It is emphasised that the purpose of this category of racing is to emulate, as far as is practicable, racing of touring cars under Appendix J regulations which were current until 31 December, 1964. Under the spirit of these regulations, over-restoration of vehicles, including the use of technology, parts or equipment not available within the period in question, are not acceptable and will render the vehicle ineligible. The Historic Eligibility Committee will interpret these regulations and determine any eligibility matters relating thereto in accordance with this spirit.

Group Nc – Touring Cars (1965-1972)

Group Nc is an historic group introduced on 1 January, 1995, to cater primarily for vehicles of a make and model which competed in Australia between 1 January, 1965, and 31 December, 1972 in either the Australian Touring Car championship and in races specifically for 3rd Category Group C Improved Production Touring Cars.

During the 1965-1972 period the rules for the vehicles evolved significantly, therefore the Group Nc rules have been established to enable competition under a common set of rules which reflect the nature of top-level car racing in the period.

It is envisaged that most vehicles in this class will not have a racing history and these are acceptable provided they are accurate in detail both mechanically and visually. Vehicles with a racing history may be presented in the most predominant form in which they were raced in the period, including the original sponsor signage, even though this specification may not fully conform with these rules.

A list of eligible vehicles and vehicle specification sheets for the more popular models are under preparation and will be available from CAMS.

1. ELIGIBILITY

1.1 Touring Cars of a make and model which competed in Australia between 1 January, 1965 and 31 December, 1972 in either the Australian Touring Car Championship or in races specifically for 3rd Category Group C Improved Touring Cars.

1.2 Vehicles shall compete in the following capacity classes:

| | |
|---------|-----------------|
| Class E | Up to 1500cc |
| Class D | 1501cc - 2000cc |
| Class C | 2001cc - 3500cc |
| Class B | 3501cc - 5000cc |
| Class A | Over 5001cc |

1.3 Owners of recognised vehicles with a competition history during the period are encouraged to present the vehicle in its original format evident at a given point in its history. Historic precedence will prevail over the following regulations with regard to these vehicles. Proof of this precedence falls to the owner and acceptance of it is at the absolute discretion of CAMS.

1.4 For a vehicle to be constructed, approval must be given by CAMS. The applicant must provide proof that the particular make and model competed in races described in 1.1 above.

1.5 A comprehensive detailed specification of each make and model and the permitted modifications for that vehicle will be provided upon approval for construction being granted by CAMS.

2. BODY

The bodywork, fittings and interior trim in its entirety must be as supplied by the manufacturer.

2.1 Body Modifications

Body modifications may be made, provided that the following restrictions are observed:

The inner lip of the wheel opening may be folded back for tyre clearance.

Mudguard extensions may be used if homologated.

The driver's seat may be replaced with a CAMS-approved racing seat.

The steering wheel may be replaced with a sports steering wheel of 330mm minimum diameter.

Floor coverings may be removed.

The use of under trays, fairings etc designed to improve the aerodynamic form of the vehicle are not permitted unless supplied as standard equipment for the make and model. If brake cooling ducts or scoops are fitted, they must be separated by a minimum of 300mm, so as not to form an aerodynamic aid and their sole function shall be to assist in the supply of air to the brakes.

Additional instruments may be added providing all original instruments and switches remain intact and that additional equipment is fitted to a separate panel.

3. ENGINE

Mechanical modifications are permitted subject to the following restrictions:

The original type and design of cylinder block and crank case must be employed. The bore may be increased to a maximum of 1.5mm, the stroke must remain standard as specified for the make and model.

Dry sump lubrication systems are not permitted unless fitted as original equipment (lubrication may be modified and additional cooling provided).

The original type and design of cylinder head casting must be employed; it may be modified provided that such modification is achieved only by the removal of metal.

Electronic ignition devices are not permitted unless fitted as original equipment.

4. INDUCTION

Fuel injection is not permitted unless fitted as original equipment.

Carburettors of a make and model not available during the period are not permitted.

5. TRANSMISSION

The original type and design of transmission and drive train assemblies including the number of forward and reverse ratios, assembled and operating as originally supplied by the manufacturer shall be retained. The use of alternate ratios is permitted. Any form of locking differential is permitted. Fully floating hubs are permitted. The gear lever may be modified but the original shift pattern must be retained.

Group Nc – Touring Cars (1965-1972) (continued)

6. SUSPENSION

The original configuration of suspension whether by leaf spring, coil spring, torsion bar, air, rubber etc for the make and model must be retained. The following modifications are permitted:

Modifications to ride height are free; shock absorbers are free.

Additional control arms and equipment may be added but must not override the original component function.

Spherical joints may not be used to replace existing components.

The original wheelbase dimensions must be retained. The track may be increased by not more than 50mm.

7. BRAKES

The original form and type of braking system must be employed, eg disc/drum.

Components may be replaced with those from another model from the same vehicle manufacturer produced before 31 December, 1972, provided there is no increase in the swept area of the disc or drum.

Dual/tandem master cylinders may be used. Brake bias must not be adjustable from the driver's compartment.

8. WHEELS AND TYRES

Wheels may be replaced with period style alloy wheels. Maximum rim width permitted is:

- Class A and B maximum 8 inches
- Class C and D maximum 7 inches
- Class E maximum 6 inches

The same diameter wheels must be those used on the model during the group period. Tyres must be of approved tyre radial or cross-ply construction with a minimum aspect ratio of 60 percent as determined by the Tyre and Rim Association. (Refer Na, Nb, Nc, Sa, Sb and Sc tyre list, page 8-30).

9. COOLING SYSTEM

The radiator may be replaced but must retain its original location and support panel opening. The radiator cooling fan may be removed. An electric fan may be fitted.

10. FUEL TANK

The fuel tank may be foam-filled or replaced with a tank of the same dimensions and capacity to the same location.

11. SAFETY REQUIREMENTS

11.1 A laminated windscreen is required to be fitted in all vehicles.

11.2 A roll cage conforming with Schedule J is required to be fitted in all vehicles. Side intrusion bars and other additional braces are permitted provided they do not pass through any part of the bodywork. The roll cage must not be used as a means of increasing the structural strength of the vehicle.

11.3 Foam filling of fuel tanks is permitted. The fuel tank may not be moved from its original location.

12. ADVERTISING

No advertising material or sign may be distributed from or carried on any vehicle in this category provided that this rule shall not apply to the manufacturer's usual name plate. CAMS reserves the right to permit also the display – in neat, unobtrusive lettering – of the name of the entrant and/or the driver and/or the State of his residence on the scuttle or the side of the vehicle. The total area of all such signs shall not exceed 75mm in height and 600mm in length on each side of the vehicle.

Club badges of an acceptable motoring club can appear on the vehicle. Each badge must be not larger than 150mm by 100mm and must be placed below the window line. Only two such badges are permitted.

The territory of origin of the driver may be shown on the vehicle. Each sign must be not larger than 100mm by 150mm and must be placed below the window line. Only two such signs are permitted.

No other signs may be displayed.

13. SPIRIT OF REGULATIONS

It is emphasised that the purpose of this category is to emulate, as far as practicable, the racing of touring cars in the period from 1 January, 1965 to 31 December, 1972. Under the spirit of these regulations, over-restoration of vehicles, including the use of technology, parts or equipment not available within the period in question, are not acceptable and will render the vehicle ineligible. The Historic Eligibility Committee will interpret these regulations and determine any eligibility matters relating thereto in accordance with that spirit.

Group O – Historic Racing & Sports Racing Cars (1966-1969)

1. ELIGIBILITY

The classification of vehicles within this group will be at the absolute discretion of CAMS.

The group is intended to cater for racing, sports racing and sports cars with a competition history established in the period between 1 January, 1966 and 31 December, 1969, excluding vehicles fitted with aerodynamic devices as defined under "specific requirements" below. Formula Vee, Formula Ford and Formula 5000 cars are also specifically excluded from this group which is intended to reflect the development of wide treaded racing tyre technology and its effect on suspension and chassis design but stopping short of the period when external aerodynamic devices became a major design feature with a significant impact on cornering performance.

Consideration may also be given to the classification within this group of vehicles constructed between 1 January, 1966 and 31 December, 1969 but with a competition history established subsequent to 31 December, 1969, provided that the specification of the vehicle is consistent with the general standard of technology evident in vehicles raced during the group period and the vehicle is compatible in appearance with such vehicles.

2. SPECIFIC REQUIREMENTS

- 2.1 **Bodywork:** Bodywork must be unmodified from that fitted to the particular vehicle within the group period.

Vehicles should run with all bodywork intact unless it was customary for the particular vehicle to do otherwise (eg, some rear-engined vehicles customarily ran without the engine cover).

- 2.2 **Cockpit:** Cockpit configuration, particularly seat/s, steering wheel and instruments must be as fitted to the particular vehicle within the group period.

- 2.3 **Engine:** Internal components of the engine are free save that the original cylinder block and cylinder head/s must be used. The crankshaft stroke must remain unaltered from the period specification on the subject vehicle.

The bore may be increased to a maximum of 1.5mm beyond the dimension evident on the subject vehicle within the group period. Toothed belt drives and dry sump lubrication systems may only be used if fitted to the subject vehicle within the group period.

- 2.4 **Exhaust:** The exhaust system is free, but should be of a period type. Any vehicle which historically had a distinctive or characteristic exhaust system is encouraged to retain it.

- 2.5 **Induction:** Manifolds are free, but carburettors must be of the period make, type and number fitted to the vehicle. The size may be altered. Superchargers, fuel injection and multi-choke carburettors are permitted only if fitted to the subject vehicle within the group period and

must remain unchanged.

Turbo-charging is not permitted.

- 2.6 **Fuel:** Commercial fuel as defined by CAMS must be used (refer Schedule G). However, provided it can be demonstrated that the subject vehicle used other than commercial fuel during the group period, alternative fuels may be permitted subject to the prior approval of the Historic Commission. Such approval must be verified by appropriate endorsement in the vehicle log book.

- 2.7 **Transmission:** Gearbox housings, transaxles, the number of forward ratios and gear change mechanisms must be unaltered from period specifications on the subject vehicle.

Internal components are otherwise free.

The external components of the final drive assembly must be unaltered from period specifications. Internal components are free.

- 2.8 **Brakes:** The braking system must be of the same type fitted to the vehicle within the group period. Drum brakes may be replaced by others of period type. Cooling fins, scoops and ventilating holes may be added.

Mechanical actuation may be converted to hydraulic operation. Drum brake systems may not be replaced by disc brake systems.

Brake discs and callipers must be of the make, style and size fitted within the group period.

Dual/tandem master cylinders may be fitted.

- 2.9 **Suspension:** The suspension must be unaltered from the period specifications on the subject vehicle.

Spring rates, ride height and damper settings are free. Fore and aft axle location on beam axle vehicles may be varied. Transverse location may not be altered from group period specification.

Externally adjustable shock absorbers and "Rose" type joints are permitted only if fitted to the subject vehicle in the group period.

- 2.10 **Wheels and Tyres:** Wheels must be unaltered from period specifications on the subject vehicle in diameter, width and style. Cast alloy wheels may be replaced by wheels cast in a different material provided that the replacement remains identical in dimensions and appearance.

Tyres must have a minimum aspect ratio of 60 percent as determined by the Tyre and Rim Association unless it can be demonstrated that the vehicle was fitted with tyres of less than 60 percent in the group period. Within the limitations of availability and practicality the tyres fitted must be of the same tread width and diameter and be consistent in general appearance and tread pattern with those fitted to the vehicle or similar vehicles during the group period.

The use of motorcycle type tyres or

Group O – Historic Racing & Sports Racing Cars (1966-1969) (cont'd)

"slick" treaded tyres will normally be prohibited but the use of grooved slicks may be permitted on individual vehicles. The tread pattern of each grooved slick must be to period specifications and approval for the use of such tyres must be verified by appropriate endorsement in the vehicle log book. **Prior approval for the use of grooved slicks must be obtained from the Historic Eligibility Committee.**

- 2.11 **Electrical Equipment:** Electrical equipment must be unaltered from period specifications and be fully operable.

Electronic ignition devices are permitted if used on the vehicle in the group period but must be to historic specifications.

An electric starter motor may be fitted.

- 2.12 **Aerodynamic Aids:** Aerodynamic aids in the form of "flaps", "tabs" or "spoilers" integral with the vehicle bodywork are permitted provided they are identical to those fitted to the vehicle during the group period. The use of aerodynamic aids in the form of "wings" not comprising an integrated component of the bodywork is not permitted even if such devices were fixed to the vehicle during the group period. Aerodynamic devices of a type which were banned during the group period are not permitted.

- 2.13 **Safety Equipment:** Roll over protection and harness must be at least to the specifications evident during the group period.

CAMS recommends that competitors wear an approved full-face helmet when driving in open vehicles (refer Schedule D).

Group P – Formula 5000 Racing Cars (Pre-1978)

1. ELIGIBILITY

The classification of vehicles within this group will be at the absolute discretion of CAMS.

Factory-built Formula 5000 racing cars, specifically designed to F5000 regulations and constructed before 31 December, 1977; or Australian built specials, constructed specifically for F5000 and raced in F5000 events before 31 December, 1977. A clear line of history is required for any subject vehicle. Vehicles cannot be constructed from spares or damaged/cast-off components (a tub or chassis does not necessarily constitute a vehicle). Owners must present vehicles in their "most significant" historical format. Only modifications compatible with the group period and to that particular vehicle will be accepted. Vehicles in this group only shall be eligible for any prize or trophy awarded for a F5000 car.

2. SPECIFIC REQUIREMENTS

- 2.1 **Bodywork:** Bodywork must be unmodified in design and materials from that fitted to the particular vehicle within the group period. Vehicles shall run with all bodywork intact (particularly induction air boxes and engine covers) unless it was customary for the particular vehicle to do otherwise within the group period.
- 2.2 **Cockpit:** Cockpit configuration particularly seat, steering wheel and instruments must be as fitted to the particular vehicle within the group period.
- 2.3 **Engine:** Engine must be of the same make and type as fitted to the particular vehicle within the group period. Cylinder blocks and heads must be of pre-1978 manufacture (CAMS may consider a model run-on in certain circumstances). The bore and stroke must be as used on the subject vehicle in the group period. Other limitations on engine components in force for F5000 at 31 December, 1977 apply. Otherwise internal engine components are free. The exhaust system must be as fitted to the subject vehicle within the group period. Induction systems must be as fitted to the subject vehicle within the group period. Carburettors may not be replaced by fuel injection. Turbo-charging or supercharging is not permitted.
- 2.4 Commercial fuel as defined by CAMS must be used (refer Schedule G). However, provided it can be demonstrated that the subject vehicle used other than commercial fuel during the group period, alternative fuels may be permitted subject to the prior approval of the Historic Car Committee. Such approval must be verified by appropriate endorsement in the vehicle log book.

1977 F5000 engine regulations are reproduced hereunder:

Unsupercharged engines of V8 overhead valve

pushrod configuration, the cylinder block of which derives from a CAMS-recognised touring vehicle, of up to 5000cc capacity. The following restrictions apply:

- displacement may be obtained by alteration of the bore and/or stroke;
 - the location and/or number of camshafts may not be changed and
 - the number of main bearings may not be changed.
- 2.5 **Transmission:** The gear box/final drive housing or transaxle, the number of forward ratios and gear change mechanism must be unaltered from period specifications on the particular vehicle. Internal components are free.
 - 2.6 **Brakes:** The braking system must be of the same type fitted to the particular vehicle within the group period. Brake discs and callipers must be of the make, style, size and material fitted to the particular vehicle within the group period. Dual circuit systems are mandatory.
 - 2.7 **Suspension:** The suspension must be unaltered from the period specifications on the particular vehicle. Spring rates, ride heights, damper settings and normally adjustable geometry settings (camber, caster, toe-in) are free.
 - 2.8 **Wheels and Tyres:** Wheels must be unaltered from period specifications in size (both diameter and width) and style on the particular vehicle. Aspect ratios and tread widths must be in accordance with tyres used on F5000 vehicles within the group period
 - 2.9 **Electrical Equipment:** Electrical equipment must be unaltered from period specification. Ignition systems must be as used on the particular vehicle within the group period. Engine management systems are not permitted.
 - 2.10 **Aerodynamic Aids:** Aerodynamic aids are permitted only if fitted to the particular vehicle within the group period. Such devices must be unaltered from period specifications in design, materials and mountings. Modern wing sections and aerodynamic technology are not permitted (including ground effects).
 - 2.11 **Safety Equipment:** Roll over protection and harness must be at least to the specifications evident at the close of the group period. "On board" fire extinguisher and life support systems are recommended. A tail lamp as required in the group period must be operative. CAMS recommends that competitors wear an approved full-face helmet when driving in open vehicles (refer Schedule D).
 - 2.12 **Weight:** The minimum weight of the vehicle including coolant and lubricants, but not including fuel and driver, shall be 1350lb (613kg).
 - 2.13 **Advertising:** Advertising is not permitted, save that a particular vehicle may compete in the identical livery as was evident on that vehicle, at one point of time within the group period.

Group Q – Historic Racing & Sports Racing Cars (1970-1977)

1. ELIGIBILITY

The classification of vehicles within this group will be at the absolute discretion of CAMS.

The group is intended to cater for racing, sports racing and sports cars with a competition history established in the period between 1 January, 1970 and 31 December, 1977, and for vehicles excluded from classification within other groups of the 5th Category because of the nature of aerodynamic devices with which they are fitted. Formula Vee and Formula 5000 cars are specifically excluded from this group which is intended to reflect the development of aerodynamic technology as an aid to cornering performance but without extending to the period when such technology extended to the use of the vehicle underbody as an aerodynamic aid, ie, the wing car era.

Formula Ford vehicles classified in this group will generally be restricted to those equipped with "outboard" rather than "inboard" mounted springs and shock absorbers. Consideration will, however be given to classification of Formula Ford vehicles equipped with "inboard" mounted springs and shock absorbers where the general design standard of the vehicle is consistent with Group Q period.

Consideration may also be given to the classification within this group of vehicles constructed between 1 January, 1970 and 31 December, 1977, but with a competition history established subsequent to 31 December, 1977, provided the specification of the vehicle is consistent with the general standard of technology evident in vehicles racing during the group period and the vehicle is compatible in appearance with such vehicles.

2. SPECIFIC REQUIREMENTS

- 2.1 **Bodywork:** Bodywork must be unmodified from that fitted to the particular vehicle within the group period. Vehicles should run with all bodywork intact unless it was customary for the particular vehicle to do otherwise (eg, some rear-engined vehicles customarily ran without the engine cover).
- 2.2 **Cockpit:** Cockpit configuration, particularly seat/s, steering wheel and instruments must be as fitted to the particular vehicle within the group period.
- 2.3 **Engine:** Internal components of the engine are free save that the cylinder block, cylinder head/s and crankshaft stroke must remain unaltered from the period specification on the subject vehicle. The bore may be increased to a maximum of 1.5mm beyond the dimension evident on the subject vehicle within the group period. Toothed belt drives and dry sump lubrication systems may be used only if fitted to the subject vehicle within the group period.

Formula Ford vehicles must use whichever of either the Cortina 1600 GT engine (original engine) or the Ford Capri XL 1600 crossflow engine (updated engine) with which the vehicle was equipped during the group period. Original engines must comply in full detail with the specifications set out for such engines in the 1970/71 CAMS Manual; updated engines must comply in full detail with current Formula Ford engine regulations. Variations in original specification allowed to other vehicles classified in this group in respect of internal engine components and induction systems are not permitted on Formula Ford vehicles.

- 2.4 **Exhaust:** The exhaust system is free, but should be of a period type. Any vehicle which historically had a distinctive or characteristic exhaust system is encouraged to retain it.
- 2.5 **Induction:** Manifolds are free, but carburettors must be of the period make, type and number fitted to the vehicle. The size may be altered. Superchargers, fuel injection and multi-choke carburettors are permitted only if fitted to the subject vehicle within the group period and must remain unchanged. Turbo-charging is not permitted.
- 2.6 **Fuel:** Commercial fuel as defined by CAMS must be used (refer Schedule G). However, provided it can be demonstrated that the subject vehicle used other than commercial fuel during the group period, alternative fuels may be permitted subject to the prior approval of the Historic Eligibility Committee. Such approval must be verified by appropriate endorsement in the vehicle log book.
- 2.7 **Transmission:** Gearbox housings, transaxles, the number of forward ratios and gear change mechanism must be unaltered from period specifications on the subject vehicle. Internal components are otherwise free.

The external components of the final drive assembly must be unaltered from period specifications. Internal components are free. Torque biasing, limited slip and locked differentials are not permitted in Formula Ford cars.

- 2.8 **Brakes:** The braking system must be of the same type fitted to the vehicle within the group period. Drum brakes may be replaced by others of period type. Cooling fins, scoops and ventilating holes may be added. Mechanical actuation may be converted to hydraulic operation. Drum brake systems may not be replaced by disc brake systems. Brake discs and callipers must be of the make, style and size fitted within the group period. Dual/tandem master cylinders may be fitted.
- 2.9 **Suspension:** The suspension must be unaltered from the period specifications on the subject vehicle.

Group Q – Historic Racing & Sports Racing Cars (1970-1977) (cont'd)

Spring rates, ride height and damper settings are free. Fore and aft axle location on beam axle vehicles may be varied. Transverse location may not be altered from group period specification.

Externally adjustable shock absorbers and "Rose" type joints are permitted only if fitted to the subject vehicle in the group period.

- 2.10 **Wheels and Tyres:** Wheels must be unaltered from period specifications on the subject vehicle in diameter, width and style. Cast alloy wheels may be replaced with wheels cast in a different material provided that the replacement remains identical in dimensions and appearance.

Within the limitations of availability the tyres fitted must be of the same tread width and diameter and be consistent in general appearance and tread pattern with those fitted to the vehicle or similar vehicles during the group period.

The use of slick tyres will be permitted on vehicles which originally used such tyres during the group period.

The make, type, specification and dimensions of tyres for use on historic Formula Ford vehicles are those tyres approved by the Historic Commission, viz: Dunlop CR82 9092.

- 2.11 **Electrical Equipment:** Electrical equipment must be unaltered from period specifications and be fully operable.

Electronic ignition devices are permitted if used on the vehicle in the group period but must be to historic specifications.

An electric starter motor may be fitted.

- 2.12 **Aerodynamic Aids:** Aerodynamic aids are permitted only if fitted to the subject vehicle during the period. Such devices must be unaltered from period specifications in both design and mounting. Modern wing sections and aerodynamic technology are not permitted.

- 2.13 **Safety Equipment:** Roll over protection and harness must be at least to the specifications evident during the group period.

CAMS recommends that competitors wear an approved full-face helmet when driving in open vehicles (refer Schedule D).

Group S – Production Sports Racing Cars (1941-1969)

Groups Sa and Sb are designed to provide a forum for competitors to race production sports cars from the '50s and '60s (sometimes known as "Classic Sports Cars"), in a form similar to period club racing.

To this extent, the modifications permitted are not intended to radically alter the individual vehicle's character or appearance and will be of an improved performance road car nature, as opposed to making the vehicle totally dedicated to outright competition.

An important consideration in forming these Regulations was the need to provide eligibility rules which will require the minimum of administration, particularly at race meetings.

People wishing to race vehicles of a more highly modified nature should consider competing in the Marque Sports Car category (Group 2B).

Group Sa – Production Sports Cars (1941-1960)

1. ELIGIBILITY

- 1.1 Production Sports Cars, as recognised by CAMS, manufactured after 1 January, 1941 but prior to 31 December, 1960 with the inclusion of certain model run-ons (eg, Mk 1 Austin Healey Sprite). Cars classified in this group will not necessarily have a racing history. Factory built, competition variants of standard production vehicles are not eligible for this group, but could be eligible for Group 1b subject to specific application.

Limited modifications, as detailed in the following regulations, are allowed to these vehicles. Where performance improving modifications are made, these should be of period nature and not out of character with the vehicle or group period.

1.2 Eligible Vehicles:

| | |
|----------------|--|
| AC Ace | |
| AC Ace | Bristol |
| Alfa Giulietta | Spider/Sprint |
| Alvis TD21 | |
| Aston Martin | DB2, DB2/4, DB4 |
| Austin A40 | Sports |
| Austin Healey | 100/4, 100/6 Mk 1, Sprite Mk 1 |
| Chevrolet | Corvette |
| Ferrari | 250 |
| Jaguar | XK120 roadster, XK140, XK150 |
| Jensen | CV8 |
| Lancia | Aurelia |
| Lotus | Elite Stage 1 & 2 |
| Mercedes-Benz | 300SL roadster |
| MG | TA, TC, TD, TF |
| MGA | 1500 roadster & coupe, 1600 roadster & coupe, 1600 deluxe, 1600 twin cam |
| Singer | Roadster - 9 & 1500 |
| Sunbeam | Alpine Series I, II & III |
| Triumph | TR2, TR3 & TR3A |

2. SPECIFIC REQUIREMENTS

- 2.1 **Chassis:** Chassis or chassis-body unit must be original and unmodified.
- 2.2 **Bodywork:** Bodywork must be original save that bumper bars and/or windscreens may be removed. Single seater type and/or wrap-around windscreens are not permitted, but other replacement screens are. Rigid removable tonneau covers are permitted.

- 2.3 **Cockpit:** The cockpit must be original save that floor coverings may be removed. The seats and the steering wheel may be replaced by others of a period style, or CAMS-approved seats (refer to page 8-28). Original instruments must be intact. Additional instruments of a period type may be fitted. Electronic tachometers may be substituted for mechanically driven units, provided they are compatible in face, style and size with the other instruments.

- 2.4 **Engine:** Cylinder block and head must be original, or a CAMS-approved alternative. Internal components of the engine are free save that the crankshaft stroke must be original. The cylinder bore may be increased by a maximum of 1.5mm beyond original dimensions. Cylinder head/s may be modified provided such modification is effected only by the removal of metal.

Toothed belt drives are not permitted.

Dry sump lubrication is not permitted.

The exhaust system is free but should be of a type compatible with the period.

- 2.5 **Induction:** Carburettors or fuel injection systems must be of the make, type and number originally fitted to the vehicle. Bore size is free. Superchargers are not permitted unless part of the original specification.

Inlet manifolds are free except that they must be of a type compatible with the period.

- 2.6 **Transmission:** Gearbox casing, gear selection mechanism and the number of forward ratios must be original. Internal components are otherwise free. External components of the final drive assembly must be unmodified from original specification. Internal components are free.

- 2.7 **Brakes:** Drum brakes may be modified or replaced with others of period type. Drums and/or backing plates may be ventilated and/or fitted with cooling fins. Drum brakes may not be replaced by disc brakes.

In case of disc brake systems, the brake discs and callipers must be original. Modification or removal of dust shields on disc brake systems is permitted. Mechanical actuation may be converted to hydraulic operation. Dual/tandem master cylinders may be fitted.

- 2.8 **Suspension:** The suspension must be unmodified from original specification, save that spring rates, ride height and damper settings may be altered. Suspension pickup points may

Group Sa – Production Sports Racing Cars (1941-1960) (continued)

not be modified. Externally adjustable shock absorbers are not permitted. Fore and aft axle location may be improved but transverse location may not be altered. Spherical or "Rose" type joints are not permitted.

A maximum of 2° negative camber will be permitted.

- 2.9 **Wheels and Tyres:** Wheels are required to be original in diameter and style (ie, steel wheels may not be replaced by alloy wheels). Rim width may not exceed 5" unless originally specified by the manufacturer, in which case the original width must be retained.

Tyres must have an aspect ratio of at least 60 percent as determined by the Tyre and Rim Association.

The maximum tyre section permitted in each eligible model will be determined and published by CAMS. (Refer Na, Nb, Nc, Sa, Sb and Sc Tyre List, on page 8-30.)

Application for the inclusion of additional tyres on the list may be made at any time. In the submission of candidate tyres, the following criteria should be borne in mind:

- the tread pattern should be distinctive and preferably of a contemporary style;
- grooved slicks are not acceptable;
- tread patterns consisting substantially of very fine and shallow sipes, which quickly disappear in use, are not acceptable;
- asymmetric patterns are acceptable subject to conformity with the above criteria.; and
- tyres designed to offer high levels of adhesion (featuring modern sticky compounds) are not acceptable.

Group Sb – Production Sports Cars (1961-1969)

1. ELIGIBILITY

- 1.1 A specific group of Production Sports Cars generally manufactured between 1 January, 1961 and 31 December, 1969, with the inclusion of model run-ons (eg, Triumph Spitfire Mk3), as detailed in the following list. Vehicles classified in this group will not necessarily have a racing history. Factory built, competition variants of standard production vehicles are not eligible for this group, but could be eligible for Groups M or O, subject to specific application.

Limited modifications as detailed in the following regulations are allowed to these vehicles. Where performance improving modifications are made, these should be of a nature and not out of character with the vehicle or group period.

1.2 Eligible Vehicles:

| | |
|------------|---|
| AC | Cobra 289, Cobra 427, 2.6 |
| Abarth | 1000 OTR Coupe |
| Alfa Romeo | Giulietta Spider, Giulietta, Spider, Veloce, GTV, 105 |

- 2.10 **Electrical Equipment:** All electrical equipment must be unmodified from the original specifications, and fully operative.

The dynamo/generator may not be replaced by an alternator.

The radiator cooling fan may be removed; electrically powered fans are permitted (refer page 8-14, Article 3.1). Electronic ignition devices are not permitted, unless included in the original specification.

- 2.11 **Optional Equipment:** Optional equipment is permitted in this group only if it is detailed in the relevant vehicle's Certificate of Description.

- 2.12 **Safety Equipment:** CAMS-approved roll bars (refer Schedule J) and seat harness (refer Schedule I) are recommended.

Roll bar assemblies must not be installed so as to become a "de-facto chassis" used to improve the torsional or beam strength of the original vehicle.

It is foreshadowed that roll bars and harnesses will become mandatory for these vehicles at some time in the future.

Foam filled, flexible fuel tanks are strongly recommended.

CAMS recommends that competitors wear an approved full-face helmet when driving in open vehicles (refer Schedule D).

| | |
|--------------------|---|
| Aston Martin | DB5, DB6, DBS (not DBS V8) |
| Austin Healey | 3000 Mk II, Mk III, Sprite, Mk II, III, IV |
| Chevrolet Corvette | All models to end 1969 |
| Datsun Sports | 1600, 2000 |
| Elva Courier | Mk 3, Mk 4 |
| Ferrari | 250 GT, 275 GTB, 275 GTS, 330, 320 GTS, 365 GTB/4, 206 Dino, 246 Dino |
| Fiat | 124 Spyder, Dino Spyder |
| Ginetta | G4 (Mk 3 only) |
| Honda | S600, S800 |
| ISO Rivolta | IRS 300, IRS 340 |
| Jaguar | E type Series One, 11/2, Two, 3.8, 4.2 |
| Lancia | Flavia and Fulvia coupes |
| Lotus | Elan S1, S2, S3, S4, Plus 2, Europa (Renault engine) |
| Marcos | All models to end 1969 |
| Maserati | 3500 GT, Sebring, Mistral, 5000 GT, Mexico, Ghibli |
| Mercedes-Benz | 230 SL, 250 SL, 280 SL |
| MG | MGB 1800 and MGB GT 1800 |

Group Sb – Production Sports Cars (1961-1969) (continued)

| | |
|----------------------------|---|
| Mk 1 and Mk 2, MGC, Midget | 948, 1098, 1275cc |
| Morgan | 4/4 Series III, IV, V, 1600, Plus 4, Plus 8 |
| Porsche | 912, 911 E, T and S (1991cc) |
| Shelby American | GT350 |
| Sunbeam | Alpine Series 4 and 5, Tiger |
| Triumph | TR4, TR4A, TR5, TR6, Spitfire Mk 1, 2, 3, GT6 Mk 1, 2, 3 1500 |
| Turner | All models to end 1969 |
| TVR | P1800, P1800S, P1800E |
| Volvo | |

2. SPECIFIC REQUIREMENTS

- 2.1 **Chassis:** Chassis or chassis body unit must be original and unmodified.

- 2.2 **Bodywork:** Bodywork must be original save that bumper bars and/or windscreens may be removed. Single-seater type and/or wrap-around windscreens are not permitted.

- 2.3 **Cockpit:** The cockpit must be original save that floor coverings may be removed. Seats and steering wheel may be replaced by others of a period style, or CAMS-approved seats (refer to page 8-28). Original instruments must be intact. Additional instruments of a period type may be fitted.

Electronic tachometers may be substituted for mechanically driven units, provided they are compatible in face, style and size with the other instruments.

- 2.4 **Engine:** The cylinder block and head must be original, or a CAMS-approved alternative. Internal components of the engine are free save that the crankshaft stroke must be original.

The cylinder bore may be increased by a maximum of 1.5mm beyond original dimensions.

Cylinder head/s may be modified provided such modification is effected only by the removal of metal.

Dry sump lubrication is not permitted, unless included in the original specification.

Toothed belt drives are not permitted, unless included in the original specification.

The exhaust system is free but should be of a type compatible with the period.

- 2.5 **Induction:** Carburettors or fuel injection systems must be of the make, type, and number originally fitted to the vehicle. Bore size is free.

Inlet manifolds are free except that they must be of a type compatible with the period.

The cooling system must remain as standard, save that the radiator core is free as to thickness. Electric fans may be added.

Supercharging is not permitted unless part of the original specification.

- 2.6 **Transmission:** Gearbox casing, gear selection mechanism and the number of forward ratios must be original. Internal components are free.

External components of the final drive assembly must be unmodified from original

specification. Internal components are free.

- 2.7 **Brakes:** Disc or drum brake systems must be of the make, model, size and type as originally fitted to the vehicle. Drums and/or backing plates may be ventilated and/or fitted with cooling fins. Drum brakes may not be replaced by disc brakes. In case of disc brake systems, the brake discs and callipers must be original. Modification or removal of dust shields on disc brake systems is permitted. Dual/tandem master cylinders may be fitted.

- 2.8 **Suspension:** The suspension must be unmodified from original specification, save that spring rates, ride height and shock absorber settings may be altered.

Suspension pickup points may not be modified.

Externally adjustable shock absorbers are not permitted unless originally fitted to the vehicle. Lever action shock absorbers where not an integral part of the suspension may be replaced by tubular shock absorbers.

Fore and aft axle location may be improved but transverse location may not be altered.

Spherical or "Rose" type joints are not permitted.

A maximum of 2° negative camber will be permitted.

- 2.9 **Wheels and Tyres:** Wheels are required to be original in diameter. Replacement of standard style wheels by period style alloy wheels will be considered upon individual application.

Rim width may not exceed 5" for vehicles of up to 1300cc swept volume, and 6" for vehicles of over 1300cc, unless otherwise equipped as standard, in which case the original width must be retained.

Tyres must have an aspect ratio of at least 60 percent as determined by the Tyre and Rim Association.

The maximum tyre section permitted on each eligible model will be determined and published by CAMS.

Tyres permitted for this group shall be subject to approval by CAMS which will maintain and publish an approved tyre list (refer Na, Nb, Nc, Sa, Sb and Sc Tyre List on page 8-30). Application for the inclusion of additional tyres to the list may be made at any time. In submitting candidate tyres, the criteria as stated in paragraph 2.9 of Group Sa should be borne in mind.

- 2.10 **Electrical Equipment:** All electrical equipment must be unmodified from the original specifications, and fully operative.

The dynamo/generator may not be replaced by an alternator.

Electronic ignition devices are not permitted, unless included in the original specification. The radiator cooling fan may be removed; electrically powered fans are permitted

Group Sb – Production Sports Cars (1961-1969) (continued)

(refer page 8-14, Article 3.1).

- 2.11 **Optional Equipment:** Optional equipment is permitted in this group only if it is detailed in the relevant Certificate of Description.
- 2.12 **Safety Equipment:** CAMS-approved roll bars (refer Schedule J) and seat harness (refer Schedule D) are recommended.

Roll bar assemblies must not be installed so as to become a "de-facto chassis" used to improve the torsional or beam strength of the original vehicle.

Group Sc – Production Sports Cars (1970-1977)

1. ELIGIBILITY

- 1.1 A specific group of non-turbo charged production sports cars generally manufactured and available in Australia between 1 January, 1970, and 31 December, 1977, with the inclusion of model run-ons (eg, Datsun 260Z) as detailed in the following list. Vehicles classified in this group will not necessarily have a racing history. Factory-built, competitive variants of standard production vehicles are not eligible for this group, but could be eligible for Historic Group Q, subject to specific application.

1.2 Eligible Vehicles

| | |
|---------------|--|
| Alfa Romeo | Spider 2000, GTV, Alfetta GT, Alfetta 2.0GTV, Montreal, SUD TI Hatch, SUD Sprint |
| Aston Martin | DB, DBS V8 |
| Bolwell | Nagari |
| Chevrolet | Corvette |
| Datsun | 240Z, 260Z, 260Z 2+2, 280Z |
| Detomaso | Pantera |
| Ferrari | 308GT4, 365GTC, 365GTC/4, 308GTB, 365GTB B/B |
| Fiat | X1/9, 1300/1500, 124 Spider 1.8, 2.0, Dino 2400 "E" Type V12 |
| Jaguar | |
| Jensen Healey | Interceptor |
| Jensen | Urraco, Espada |
| Lamborghini | Beta coupe, Spider, Monte Carlo, Coupe 20-00, 2000HF |
| Lancia | |
| Lotus | Elite S1, Eclat S1, Europa T/C |
| Marcos | 2 Litre, 2.5 Litre, 3 Litre |
| Maserati | Bora, Merak, Khamsin |
| Mercedes-Benz | 350/450SL, SLC Coupe |
| MG | BGT V8 |
| Porsche | 911 up to 3.0 litre, 914, 916, 924, 928 |
| Triumph | Spitfire IV and 1500, TR7 Coupe, Stag |
| TVR | 1300, 1600M, 2500, 3000M, Taimar |

2. SPECIFIC REQUIREMENTS

- 2.1 **Chassis:** Chassis or chassis body must be original and unmodified.
- 2.2 **Bodywork:** Bodywork must be original save

that bumper bars and/or windscreens may be removed. Single-seater type and/or wrap-around windscreens are not permitted.

2.3 **Cockpit:** The cockpit must be original save that floor coverings may be removed. Seats and steering wheel may be replaced by others of a period style. Original instruments must be intact. Additional instruments of a period type may be fitted.

Electronic tachometers may be substituted for mechanically driven units, provided they are compatible in face, style and size with the other instruments.

- 2.4 **Engine:** The cylinder block and head must be original, or a CAMS-approved alternative. Internal components of the engine are free save that the crankshaft stroke must be original.
- The cylinder bore may be increased by a maximum of 1.5mm beyond original dimensions.
- Toothed belt drives are not permitted, unless included in the original specification.
- Cylinder heads may be modified provided such modification is effected only by the removal of metal.
- Dry sump lubrication is not permitted, unless included in the original specification.
- The exhaust system is free but should be of a type compatible with the period.
- Carburettors or fuel injection systems must be of the type and number originally fitted to the vehicle. Bore size is free. Forced induction is not permitted.
- Inlet manifolds are free but they must be of a type compatible with the period.
- The cooling system must remain as standard, save that the radiator core is free as to thickness. Electric fans may be added.

2.5 **Gearbox:** Gearbox casing, gear selector mechanism and the number of forward ratios must be original. Internal components are free.

2.6 **Final Drive:** External components of the final drive assembly must be unmodified from the original specification. Internal components are free.

2.7 **Brakes:** Disc or drum brake systems must be

of the make, model, size and type as originally fitted to the vehicle.

Drums and/or backing plates may be ventilated and/or fitted with cooling fins. Modification or removal of dust shields on disc brake systems is permitted.

Dual or tandem master cylinders may be fitted.

2.8 **Suspension:** The suspension must be unmodified from original specification, save that spring rates, ride height and shock absorber settings may be altered.

Suspension pickup points may not be modified.

Externally adjustable shock absorbers are not permitted unless originally fitted to the vehicle.

Fore and aft axle location may be improved but transverse location may not be altered.

Spherical or "Rose" type joints are not permitted.

2.9 **Wheels and Tyres:** Wheels are required to be original in diameter. Replacement of standard style wheels by period style alloy wheels will be considered upon individual application.

Rim width may not exceed 5" for vehicles of up to 2000cc swept volume, and 6" for vehicles of over 2000cc, unless otherwise equipped as standard.

Tyres must have an aspect ratio of at least 60 percent as determined by the Tyre and Rim Association Manual. In all cases the fitment of the tyre to the rim must also meet requirements of that manual.

The maximum tyre section permitted on each eligible model will be determined and

published by CAMS.

Tyres permitted for this group shall be subject to approval by CAMS which will maintain and publish an approved tyre list (refer Na, Nb, Nc, Sa, Sb and Sc Tyre List on page 8-30).

Application for the inclusion of additional tyres to the list may be made at any time. In submitting candidate tyres, the criteria as stated in paragraph 2.9 of Group Sa should be borne in mind.

2.10 Electrical Equipment:

All electrical equipment must be unmodified from the original specifications, and fully operative.

Generators may not be replaced by alternators.

Electronic ignition devices are not permitted, unless included in the original specification.

- 2.11 **Optional Equipment:** Optional equipment is permitted in this group only if it is detailed in the relevant Certificate of Description.

- 2.12 **Safety Equipment:** CAMS-approved roll bar and seat harness must be fitted. Competition seat similar to those used in the period are strongly recommended.

Roll bar assemblies must not be installed so as to become a "de-facto chassis" used to improve the torsional or beam strength of the original vehicle.

Foam filled, flexible fuel tanks are strongly recommended.

CAMS recommends that competitors wear an approved full-face helmet when driving in open vehicles (refer Schedule D).

5th Category – Seats for Groups Na, Sa, Sb and Sc

The following list of after-market seats have been approved by the Historic Commission for use in 5th Category Groups Na, Sa, Sb and Sc Historic vehicles as a replacement for the standard seats.

Trim colour must be either as per the original, ie match the existing seats, or black.

It is recommended that seats with integral headrests should have seat belt slots to ensure proper location of the shoulder and lap belts. Special attention should be given to the seat mounting and seat adjustment methods (refer Section 6, Schedule C, Article 9).

A separate headrest may be used with standard seats, provided that the headrest is supported on the same structure as the seat and cannot move independently.

CAMS will maintain a list of the specific seats approved for these groups. Approved seats for these groups may be updated by CAMS Historic Commission at any time. Consult the CAMS National Office or your state Historic Eligibility Officer to obtain the up-to-date list.

Approved seats

Cobra Vintage (with headrest)
Cobra Carrera "Classic"
New Cobra Sprint
Clubman
RPM Competition "Classic"
Corbeau Clubman

Type

A
B
B
B
B
B

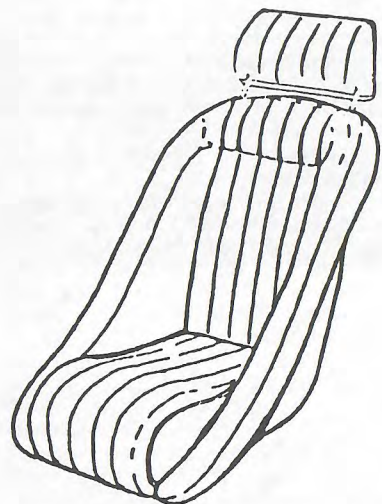

TYPE A

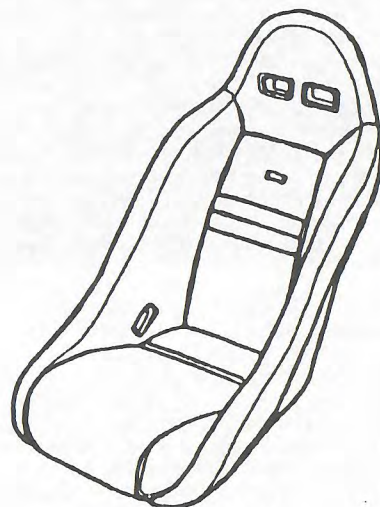

TYPE B

Groups J, K and L – List of Permitted Motorcycle Tyres

A selected list of motorcycle tyres is permitted for use on Groups J, K and L cars provided they are fitted to the correct width and profile rims, and are operated within their specified Speed and Load Index ratings.

The tyre section profile shall be as per configuration (a) of the Tyre and Rim Association of Australia manual. Aspect ratios shall comply with individual group requirements.

Tyre hardness shall generally not be lower than

68 Durometer cold (measured prior to use) and not lower than 15° (ambient).

Short life or low profile tyres will not be acceptable.

Historic period design tyres made with modern "sticky" compounds are unacceptable. Tread patterns shall be of a period historic style.

Additional tyres to those shown in the approved tyre list will be considered on application if they meet the above criteria.

| Make | Model | Size | Speed Rating (mph) | Load Limit (lb) | Rim Width |
|-------------|----------------------|---------------|--------------------|-----------------|-----------------|
| 15" | | | | | |
| DUNLOP | Qualifier K827 | 140/90-15 | H 130 | 740 | MT 2.7 - 3.5 |
| 16" | | | | | |
| AVON | SM MKII | 5.10 S16 | S 113 | 716 | MT 3.0 - 3.5 |
| AVON | Roadrunner R2 | 130/90 H16 | H 130 | 760 | MT 2.5 - 3.5 |
| CHEN SHIN | C199 | 510 H16 | H 130 | 720 | MT 3.0 - 3.5 |
| METZLER | Block K | 325-16 | H 130 | 425 | MT 1.85- MT 2.5 |
| 17" | | | | | |
| AVON | Roadrunner Universal | 130 190 H17 | H 130 | 695 | MT 2.5 - 3.5 |
| BRIDGESTONE | RS-10 | 250-17 | S 113 | 290 | 1.35-1.6, WM1 |
| BRIDGESTONE | RS-10 | 325-17 | S 113 | 440 | MT 1.85 - 2.5 |
| CHEN SHIN | C119 | 4.50/85-H17 | H 130 | 645 | 2.5 - 3.00 |
| | C180 | 300-17 | S 113 | 385 | 1.6 - 2.15 |
| | C180 | 325-17 | S 113 | 440 | MT 1.85 - 2.5 |
| | C180 | 350-17 | S 113 | 493 | 1.85 - 2.50 |
| 18" | | | | | |
| AVON | SM MKII | 4.00 S18 | S 113 | 617 | 2.15 - MT 3.00 |
| BRIDGESTONE | RS10 | 250-18 | S 113 | 250 | 1.35 - 1.6 |
| BRIDGESTONE | RS10 | 325-18 | S 113 | 440 | MT1.85 - MT2.5 |
| CHEN SHIN | C199 | 3.50/3.75 H18 | H 130 | 493 | 1.85 - 2.50 |
| | C199 | 4.10/4.25 H18 | H 130 | 551 | 2.15 - 3.00 |
| | C199 | 4.25/4.60 H18 | H 130 | 617 | 2.50 - 3.00 |
| | C199 | 4.50/4.85 H18 | H 130 | 645 | 2.50 - 3.00 |
| | C180 | 300-18 | S 113 | 385 | 1.60 - 2.15 |
| | C180 | 350-18 | S 113 | 493 | 1.85 - 2.50 |
| | C180 | 400-18 | S 113 | 617 | 2.15 - MT3.00 |
| | C180 | 450-18 | S 113 | 661 | 2.50 - 3.00 |
| DUNLOP | K70 | 300-18 | S 113 | 360 | 1.60 - 2.15 |
| | K70 | 350-18 | S 113 | 450 | 1.85 - 2.50 |
| | K70 | 400-18 | S 113 | 570 | 2.15 - MT3.00 |
| | K81 TT100 | 360-18 | H 130 | 460 | 1.60 - 2.50 |
| | K81 TT100 | 410-18 | H 130 | 575 | 2.15 - 3.00 |
| | K81 TT100 | 425-18 | H 130 | 595 | 2.50 - 3.00 |
| | K181 | 100-900 V18 | V 130+ | 493 | 2.15 - 2.75 |
| | K700 | 150/70 VR18 | | | |
| METZLER | Block K | 400-18 | P 33 | 620 | 2.15 - MT3.00 |
| MICHELIN | M38 | 300-18 | S 113 | 360 | 1.60 - 2.15 |
| | M38 | 350-18 | S 113 | 490 | 1.85 - 2.50 |
| | M38 | 400-18 | S 113 | 623 | 2.15 - MT3.00 |
| YOKOHAMA | 12200 | 140/70 VR18 | | | |

Groups Na, Nb, Nc, Sa, Sb and Sc – Tyre List

This approved tyre list relates to tyre characteristics applying at the date of publication. In the event of a tyre manufacturer effecting reformulation of an approved tyre (particularly in respect of tread pattern or stickiness of compound) such reformulation normally will result in the approved status of the tyre lapsing.

For Na, the minimum aspect ratio permitted is 65 percent. For Nb, Nc, Sa, Sb and Sc, the minimum

aspect ratio permitted is 60 percent (effective 1 January, 1997).

CAMS will maintain a list of the specific tyres approved for these groups. Approved tyres for these groups may be updated by CAMS Historic Commission at any time. Consult the CAMS National Office or your state Historic Eligibility Officer to obtain the up-to-date list.

| Make | Model | | |
|------------------------|--|------------------|----------------|
| ADVAN (refer Yokohama) | A008 | | |
| AVON | Turbosteel | Turbosport | Turbospeed |
| BRIDGESTONE | 319V | RD229V | RD339V |
| RE71 | RD229 | RD339 | RE88 |
| | S310 (10" only) | S330 | S340 |
| | S370 | S372 | Supercat |
| CONTINENTAL | CV51 | CZ91 | |
| DUNLOP | SP Sports D40 | Monza D8 | Daytona |
| | Le Mans A4 | Grand Sport G5 | Formula W-1 |
| | CR 48 (R6) | CR 65 (R7) | |
| FALKEN | GB RS410 | | |
| FIRESTONE | Eurosteel S211 | S330 | H330 |
| | F560 | F630 | |
| | Firehawk | | |
| | Cavallino Sport 200 | | |
| GOODRICH | Comp T/A | | |
| GOODYEAR | Eagle NCT | Grand Rally S | |
| | Vector | Ducaro | Eagle NCT-2 |
| | Eagle VR | Eagle CA | |
| | GTR | GT Sport 70 | |
| | Bluestreak Sportscar Special | | |
| HANKOOK | Optimo Plus 827 | 838 | |
| HOOSIER | Street TD | Vintage TD | Hoosier TD 10" |
| KLEBER | GTS | T1 | C2 |
| | C2T | C20H | C50H |
| | C40H | | |
| KUMHO | 737, 755, 756, 766, 768, 771, 772, 777A, 782, 788, 790 | | |
| MICHELIN | XVS | MXV | MXL |
| | TDX-V | MX | XDX |
| | XAS | XZX | XWX |
| | MXV2 | MXV3 | MXV3A |
| | MXT | MXF | XM+S244 |
| OHTSU | Falken FK | | |
| PIRELLI | CN36 | P6 | P7 |
| | P77 | P700 | P5 |
| | P8 | P4 | P44 |
| | P600 | P700Z | P500 |
| | Stelvio | CH36 | CH67 |
| | P2000 | P4000E | |
| RIKEN | G4-06 | GR-14 | GR-16 |
| | GR-301 | | |
| SUMITOMO | HTR60H | HTR60V | |
| TOYO | 600 | 600CI | 6004D |
| | 600FI | 600F4 | 600F7 |
| | 600F3 | 600F5 | 600F8 |
| | 800 Plus | Proxus-H4 | |
| UNIROYAL | Rallye 340/65 | | |
| YOKOHAMA (refer ADVAN) | AVS161 | AX321 | S707 |
| | Y352 | GX501 (10" only) | A008 |
| | A509 | AVS | |

General Requirements of Automobiles

Schedule A

ALL AUTOMOBILES SHALL, OF NECESSITY, IN ALL COMPETITIONS:

1. comply with the definition of an automobile;
2. be fitted with some form of protection between engine and driver's compartment suitable and sufficient for preventing the passage of flame;
3. be so constructed that the driver is protected from the entry of foreign matter into the driving compartment from the road or road wheels;
4. be equipped with a transmission system so arranged that:
the propeller shaft and universal or Cardan joints, if passing through or beneath the passenger compartment, shall be under the floor boards, or fitted in tubes or casings. Such floorboards, tubes or casings shall not be of a temporary nature, but shall be joined together and firmly fixed to the coachwork or chassis. Any chains used in the transmission of power or driving any auxiliary component shall be effectively guarded;
5. be arranged so that all fuel tanks are vented externally to the bodywork;
6. if not registered for use on public roads, have any steering column locking device removed;
7. if required to be fitted with roll-over protection, be equipped with such protection only in accordance with the provisions of Schedule J; unless specifically otherwise approved, use only commercial fuel, as defined (Schedule G);
8. be fitted with windows (including wind-screens) which if of other than glass, are clear, transparent and free of colouring; glass windows must not be coloured or tinted after production;
9. have displayed on the dashboard a valid CAMS registration label for the relevant competition as determined by CAMS from time to time,
10. be fitted with safety harness or seat belts as prescribed in Schedule I;

Schedule B

ALL AUTOMOBILES SHALL, OF NECESSITY, IN ALL SPEED EVENTS:

1. (if fitted with rear hinged bonnets and/or panels) be fitted with at least two independent fastening systems, of adequate strength and limited extensibility, which simultaneously hold the bonnets or panels closed;
2. (if fitted with crankcase breather/s discharging to atmosphere) have fitted to such breather/s an oil-trap container (which must be empty at the start of the competition) of at least two litres (for cars of under 2000cc) or three litres (for cars of over 2000cc) except in Autocross, Rallycross and other events on unsealed

surfaces, save however, that Supplementary Regulations may require fitment for any particular event;

3. (other than in Single- and Multi-car Speed Events) be fitted with a roll bar or roll cage and safety harness complying with such specifications as are determined by CAMS from time to time (see Schedules J and I);
(NOTE: structurally unmodified fixed roof closed cars may compete in events other than National Race Meetings without roll-over protection)
4. be fitted with a fire extinguisher or fire extinguishing system in working order and of a type and capacity as specified in Schedule H as is appropriate;
5. be so constructed that, in the event of any breakage, the tailshaft, its components or mountings shall be effectively prevented from striking the ground;
6. be fitted with wheels which meet the specifications determined by CAMS from time to time (see Schedule E);
7. be so constructed that any aerodynamic device fitted is in accordance with specifications determined by CAMS from time to time (see Schedule F);
8. comply with any Supplementary Regulations for a specific event which requires the fitment of locking or wiring devices adequate for the prevention of any loosening of any oil drain plug;
9. be fitted with a scatter shield if required (see Schedule M);
10. on each throttle, whether butterfly, slide or other type, be fitted with a return spring which in the event of the throttle linkage becoming detached will in all cases return each throttle to the closed position;
11. be fitted with a double circuit braking system so arranged that the pedal normally operates on the four road wheels and, in the event of leakage at any point in the braking system, the pedal shall still control two wheels on the same axle. Provided that in "straight-line" Sprint Events, and in events exclusively for historic or vintage cars, braking systems operating on two wheels of the same axle shall be acceptable;
12. be fitted with an operable reverse gear;
13. be fitted with an exhaust system the outlet pipe/s of which shall be directed either rearwards or sideways. If rearwards, their orifices shall be between 100mm and 450mm above the ground and they shall not protrude by more than 150mm beyond the rearmost portion of the car. If they are directed sideways, their orifices must be located aft of a vertical plane passing through the midpoint of the wheelbase. They may neither project in any way beyond the maximum width of coachwork nor terminate at a point more than 50mm

General Requirements of Automobiles (continued)

within the projected plan of the coachwork. Except on 1st Category cars, adequate protection shall be provided to prevent heated exhaust pipes from causing burns.

14. have, on the external coachwork, a blue triangle of sides 150mm, which indicates the position of the battery or the isolation switch; and
15. be fitted with a flame- or liquid-proof bulkhead, which may be of transparent material, which effectively separates the compartment occupied by the crew from any component of the fuel tank or fuelling system.

Notwithstanding the above requirements cars registered for road use shall not, when competing in one-car-at-a-time speed events, be required to comply with the provisions of sub-sections 2, 3, 5, 8 and 9 of this Schedule.